

热保护型熔断电阻器 (主动控制)

TRXF (Active Protection)

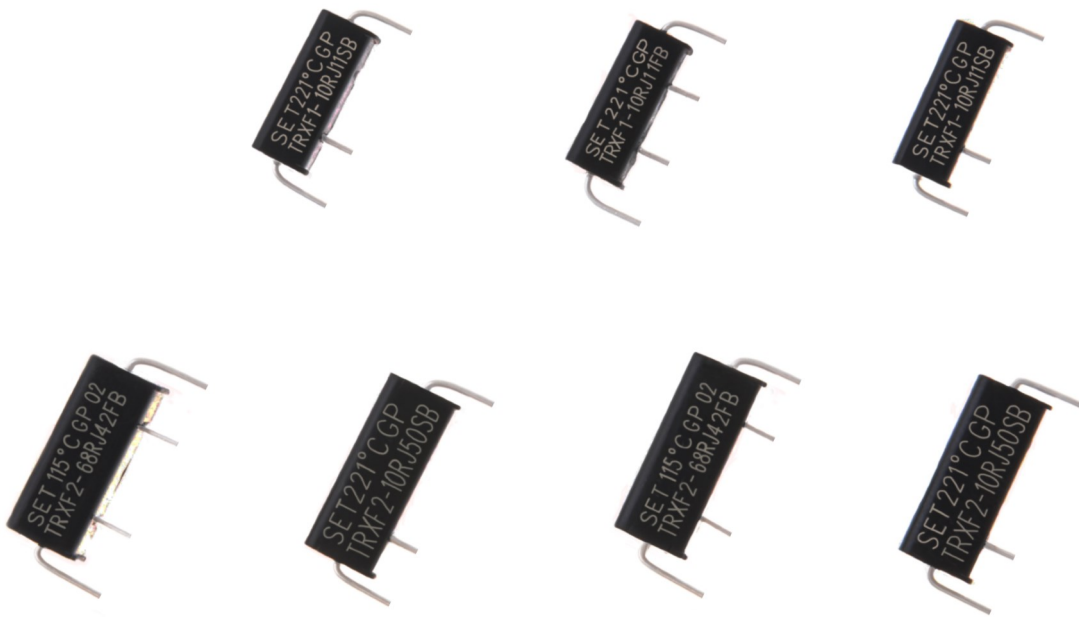

特征 Features

- 专利产品
- 过流保护
- 过温保护
- 小型化产品
- 环保型产品

- Patented Product
- Over Current Protection
- Over Temp. Protection
- Miniaturized Product
- RoHS & REACH Compliant



TRXF

TRXF

热保护型熔断电阻器 (主动控制)

TRXF (Active Protection)

热保护型熔断电阻器 (主动控制) 特征概览
Thermal-Link & Fusing Resistor (TRXF - Active Protection) Features Overview

页码 Page				
外形 Shape	 <p>SET 145°C GP 001 TRXF1-47RJ07SB</p>		 <p>SET 145°C GP 001 TRXF2-47RJ46FB</p>	
结构 Structure	3只脚 3 Pins		4只脚 4 Pins	
阻值 R Resistance Range	(0.47 ~ 600) Ω		(1 ~ 1000) Ω	
功率类型 P Power Type	1 W		2 W	
尺寸 Dimensions	11.5 mm × 4.0 mm × 5.0 mm		14.0 mm × 5.5 mm × 6.0 mm	
T_f 额定动作温度 Rated Functioning Temp.	(115 ~ 150) °C			

参照标准：IEC60063-2015，阻值可根据客户需求定制。
According to IEC60063-2015, resistance can be customized.

引脚成型方式及尺寸可根据客户需求定制。
The forming modes and length of lead wires can be customized.

TRXF

TRXF

热保护型熔断电阻器 (主动控制)

TRXF (Active Protection)

产品描述 Description

赛尔特公司的热保护型熔断电阻器(TRXF)是一款将温度保险丝(ATCO)内置于线绕熔断电阻器(RXF)之中，并与线绕熔断电阻器形成特殊连接的主动控制型的过温过流保护元件；它是一款既能利用温度保险丝的过温熔断特性实现过温保护功能，又能利用熔断电阻过流发热熔断温度保险丝的特性实现过流保护功能的独特的电路保护元件。

SETsafe | SETfuse Thermal-link & Fusing Resistor (TRXF) is an active protection integrated component with Over Temp. and Over Current Protections, in which Alloy Thermal-Link (ATCO) is built in the core of Fusible Wirewound Resistor (RXF) and forming special connection with RXF. It is not only able to proceed over temp. protection by ATCO itself but also proceed over current protection by RXF transferring heat to ATCO to open the circuit.

应用 Applications

- LED驱动 LED Drivers
- 电热毯 Electric Blanket

结构图 Structure

3只脚 Pins

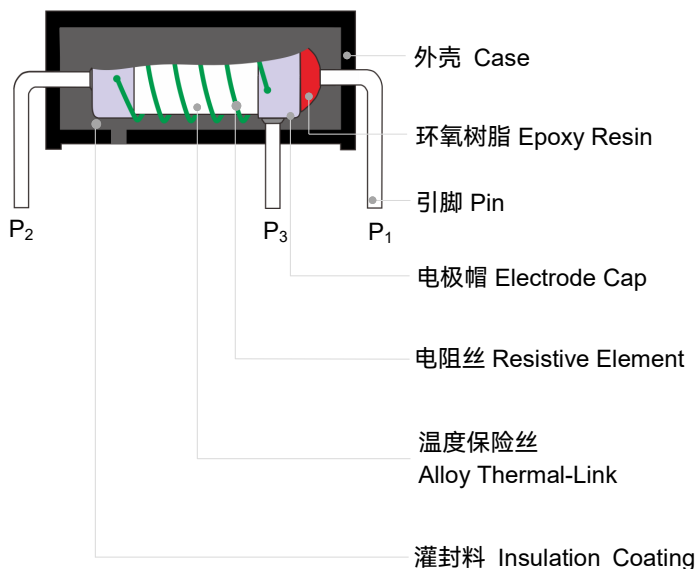

4只脚 Pins

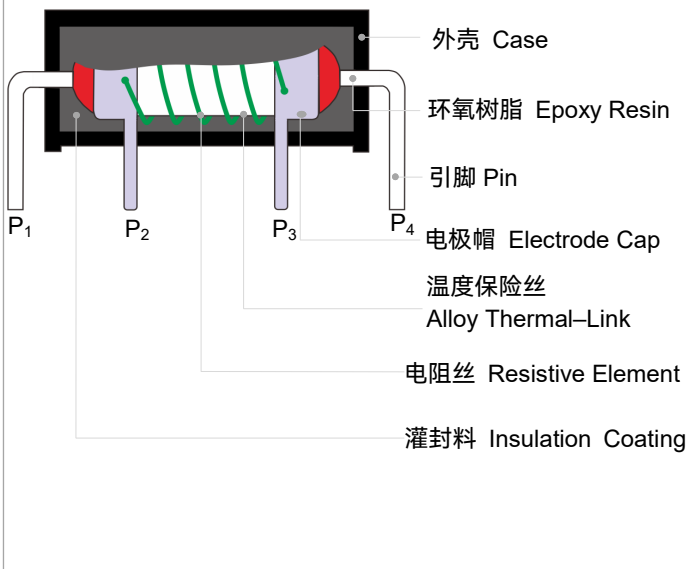

TRXF

TRXF

热保护型熔断电阻器 (主动控制)

TRXF (Active Protection)

型号说明 Product Number System

TRXF 1 - 4R7 J 46 S B

外壳类型 Case Type

B : 方形 Square

引出脚类型 Pin Type

S : 三只脚 Three Pins

F : 四只脚 Four Pins

温度保险丝代码 ATCO Code

TRXF1 系列 Series		TRXF2 系列 Series	
代码 Code	ATCO 型号 Model	代码 Code	ATCO 型号 Model
03	V2 (115 °C)	42	B2 (115 °C)
04	V3 (125 °C)	43	B3 (125 °C)
05	V4 (130 °C)	44	B4 (130 °C)
06	V5 (135 °C)	45	B5 (135 °C)
07	V6 (145 °C)	46	B6 (145 °C)
08	V7 (150 °C)	47	B7 (150 °C)

阻值公差 Resistance Tolerance (%)

J : ± 5

K : ± 10

标称阻值 Rated Resistance (Ω)

R47 : 0.47

4R7 : 4.7

47R : 47

470R : 470

功率类型 Power Type (W)

1 : 1

2 : 2

产品类别 Product Category

TRXF : 热保护型熔断电阻器

Thermal-Link & Fusing Resistor

热保护型熔断电阻器 (主动控制)

TRXF (Active Protection)

产品标示 Marking

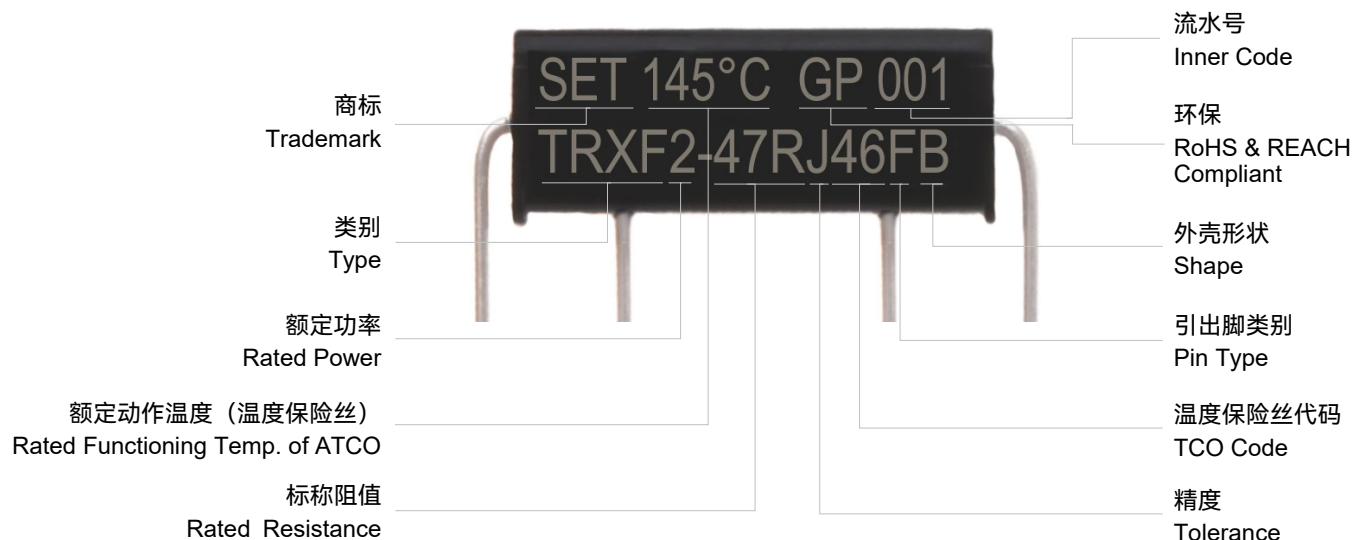

产品专利 Patents

名称 Name	区域 Region	专利类别 Category	专利号 Patent No.
一种温度保险丝与电阻结合的装置 A Device that Combines Thermal-link and Resistor	中国 China	实用新型 Utility Model	ZL 201020697438.7
	美国 United States	发明专利 Invention Patent	US 9240300

认证信息 Agency Approvals

认证信息 Agency Approvals		标准 Standards	文件号 No.
	cURus	UL 1412	E324712
	TUV	IEC 60065	R50279979
	CQC	SJ 2865	2020980205000191 2020980205000194

执行标准 Designed to Standards

标准 Standards	标准名 Standards Name
IEC 60065	Audio, Video and Similar Electric Apparatus – Safety Requirements
UL 60691	Thermal-Links – Requirements and Application Guide
UL1412	Fusing Resistors and Temperature-Limited Resistors for Radio- and Television-Type Appliances
GB/T 9816	《热熔断体的要求和应用导则》 Thermal-Links-Requirements and Application Guide
GB/T 5729	《电子设备用固定电阻器总规范》 Fixed Resistors for Use in Electronic Equipment

热保护型熔断电阻器 (主动控制)

TRXF (Active Protection)

术语 Glossary

项目 Item	描述 Description
RXF	<p>线绕熔断电阻器 Fusible Wirewound Resistor</p> <p>电阻丝绕在瓷基体上再经过绝缘封装处理而成的功率型电阻器。当通过电流超过预定值时，能在预定的时间切断电流。线绕熔断电阻器为一次性熔断元件，不可恢复。 — (SETsafe SETfuse 企业标准)</p> <p>A power resistor which is made by winding a resistive element on a ceramic core, and the core is coated by insulation coating. It intends to interrupt a current flow at a predetermined time when the current exceeds a predetermined value. Fusible Wirewound Resistor is disposable fuse elements and is non-recoverable. — (SETsafe SETfuse Standards)</p>
ATCO	<p>合金型温度保险丝 Alloy Thermal-Link</p> <p>合金型温度保险丝，由易熔合金作为感温部件的热熔断体。 — (GB/T 9816.3)</p> <p>Alloy Type Thermal-Link, Alloy is the thermal element.</p>
R	<p>标称阻值 Rated Resistance</p> <p>电阻器设计所确定的，通常在电阻器上标出的阻值。 — (GB/T 5729)</p> <p>Resistance value for which the resistor has been designed, and which is generally used for denomination of the resistor. — (IEC 60115-1)</p>
P ₀	<p>实际功率 Actual Power</p> <p>在允许的工作温度范围内，TRXF可使用的最大功率。 — (SETsafe SETfuse 企业标准)</p> <p>The Max. power of TRXF can be used within the allowable operating Temp. range. — (SETsafe SETfuse Standards)</p>
U _N	<p>额定电压 Rated Voltage</p> <p>用标称阻值和额定功耗乘积的平方根计算出来的直流电压或交流电压有效值。 — (GB/T 5729)</p> <p>The d.c. or a.c. r.m.s. voltage calculated from the square root of the product of the rated resistance and the rated dissipation. — (IEC 60115-1)</p>
T _f	<p>额定动作温度 Rated Functioning Temp.</p> <p>在仅通以不超过10 mA的探测电流的条件下，测得的使热熔断体导电状态改变的温度。 — (GB 9816.1)</p> <p>The temp. of the Alloy Thermal-Link which causes it to change the state of conductivity with a detection current up to 10 mA as the only load. — (IEC 60691)</p> <p>允许偏差 Tolerance: T_f + 0 / -10 °C (GB 9816.1, EN 60691, K60691)</p> <p>允许偏差 Tolerance: T_f ± 7 °C (J60691)</p>
Fusing Temp.	<p>实测熔断温度 Fusing Temp.</p> <p>置于油池中，通10 mA以下的负载电流，每分钟升温0.5 °C ~ 1 °C，测断开温度。 — (GB 9816.1)</p> <p>The temp. of the Alloy Thermal-Link which causes it to change its state of conductivity is measured with silicone oil bath in which the temp. is increased at the rate of 0.5 °C to 1 °C / minute, with a detection current up to 10 mA as the only load. — (IEC 60691)</p>
T _h	<p>保持温度 Holding Temp.</p> <p>TCO持续通额定电流168 h不断开温度。 —(GB 9816)</p> <p>The maximum temp. at which a Alloy Thermal-Link (ATCO) will not change its state of conductivity when conducting rated current for 168 h. —(IEC 60691)</p>
TCR	<p>电阻温度系数 Temp. Coefficient of Resistance</p> <p>两个规定温度之间的阻值相对变化除以产生这个变化的温度之差。 — (GB/T 5729)</p> <p>Relative variation of resistance between two given temp. divided by the difference in the temp. producing it. — (IEC60115-1)</p>

热保护型熔断电阻器 (主动控制)

TRXF (Active Protection)

电热毯保护典型应用 Typical Application for Electric Blanket (4 Pins)

电路原理图 Schematics

电热毯保护的推荐应用，仅供参考。

For Electric Blanket Protection Application, For Reference Only.

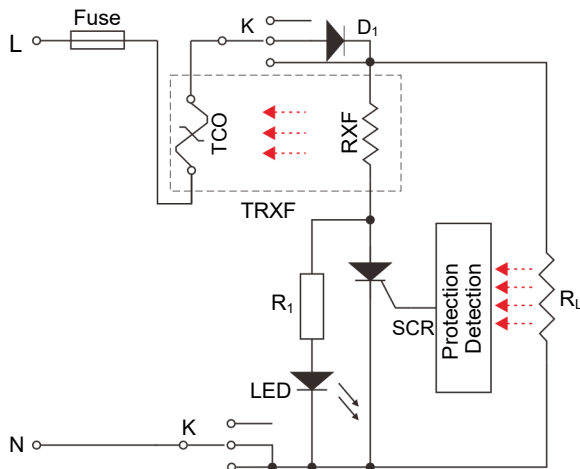

工作原理 Operating Principle

电热毯工作正常时，可控硅(SCR)呈截止状态，电流流过内部的温度保险丝 (ATCO) 至负载 R_L 正常发热取暖，LED指示灯亮；当电路异常时，保护检测触发SCR呈导通状态，R流过电流迅速发热，热量快速传递给ATCO，使其快速熔断，切断电源回路，LED指示灯熄灭，实现安全保护的功能。

When electric blanket works normally, the SCR is off, the current flows through the internal ATCO to R_L to normal heat, and the LED is on. Once the circuit is abnormal, the detective circuit triggers SCR on, and current flows through R and heats up rapidly. The heat is transferred to ATCO and ATCO opens the circuit quickly, and LED indicator is off.

过额熔断图 Over Rated Power Fusing Graph

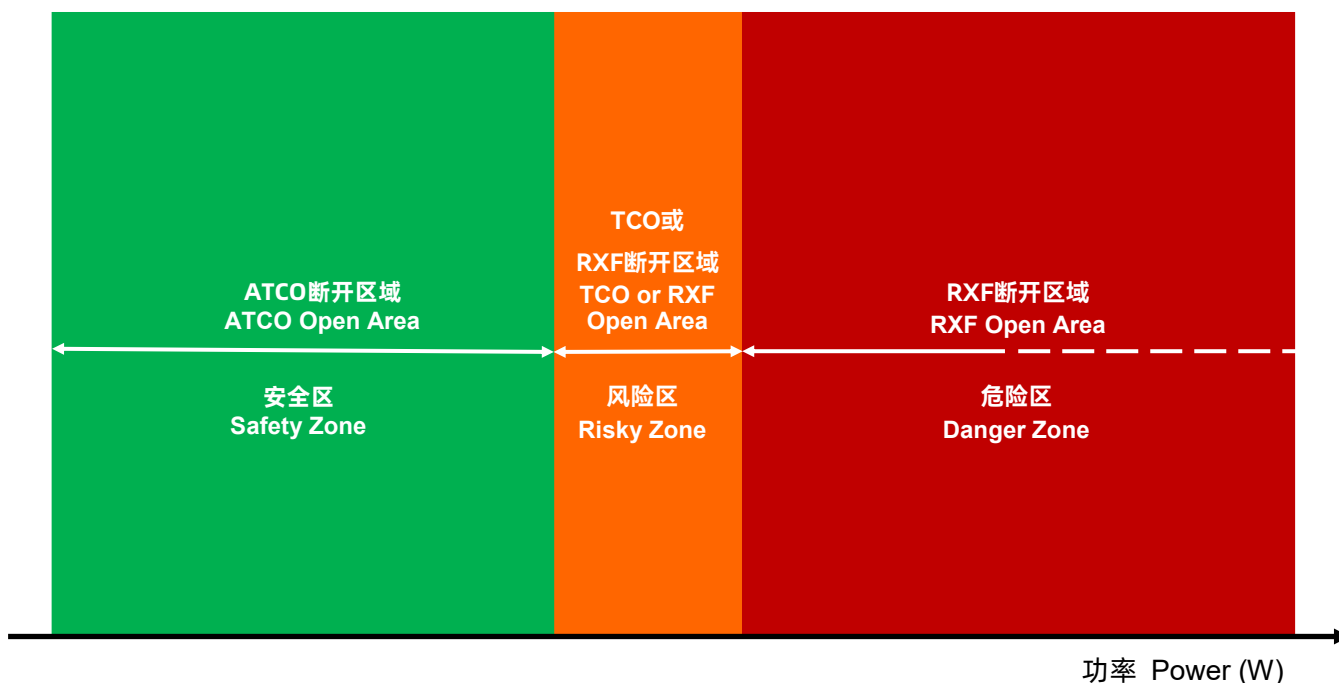

热保护型熔断电阻器 (主动控制)

TRXF (Active Protection)

性能测试 Performance Test

机械性能测试 Mechanical Performance Test

项目 Item	试验条件 Test Condition	判定标准 Criterion
拉力测试 Tensile Test	对引线施加10 N的拉力，保持60 s。 A pin withstand 10 N × 60 s	无可见损伤 No Visible Damage $\Delta R \leq \pm (1\%R + 0.05 \Omega)$
扭转测试 Twist Test	引脚从根部折弯90° (折弯位置距本体2 mm)，扭转180° × 2次。 A pin 2 mm away from body, bent 90°, twist 180° × 2 times.	无可见损伤 No Visible Damage $\Delta R \leq \pm (1\%R + 0.05 \Omega)$

环境试验 Environmental Test

项目 Item	试验条件 Test Condition	判定标准 Criterion
温度循环 Temp. Cycle	1. - 55 °C × 30 minutes 2. 室温 Room Temp. × (10 ~ 15) minutes 3. 85 °C × 30 minutes 4. 室温 Room Temp. × (10 ~ 15) minutes 5. 步骤1至4循环5次 5 Cycles from Step 1 to Step 4	$\Delta R \leq \pm (2\%R + 0.05 \Omega)$

电气特性测试 Electrical Performance Test

项目 Item	试验条件 Test Condition	判定标准 Criterion
电阻温度系数 TCR	$TCR = \frac{R_2 - R_1}{R_1 (T_2 - T_1)} \times 10^6$ R ₁ : 25 °C时的电阻值 Resistance Value at 25 °C R ₂ : 125 °C时的电阻值 Resistance Value at 125 °C T ₁ : 25 °C, T ₂ : 125 °C	在规定值范围内 Within Specified Value
短时间过载 Short-Time Overload	通2.5倍的额定电压，持续5 s。 $2.5U_N \times 5 s$	无可见损伤 No Visible Damage $\Delta R \leq \pm (2\%R + 0.05 \Omega)$
绝缘电阻 Insulation Resistance	包箔法，在引线与金属膜之间施加500 VDC。 Foil Method: Apply 500 VDC between both terminations of the resistor connected together as one pole and the metal foil as the other pole.	绝缘电阻: $\geq 1,000 M\Omega$ Insulation Resistance $\geq 1,000 M\Omega$
耐电压 Voltage Proof	包箔法，引线与金属箔膜之间施加350 VAC (涂覆型) 或900 VAC (外壳型，套管型)，保持1 minute。 Foil Method: Apply 350 VAC × 1 minute (coating type) or 900 VAC × 1 minute (case type, tube type) between terminations and the metal foil.	不得有弧光、击穿等现象发生 No Breakdown or Flashover
熔断测试 Fusing Test	对电阻器施加规定的测试电流 (恒流源) Apply specified test current to the resistor (constant current source).	温度保险丝熔断时间 $\leq 60 s$ Fusing Time $\leq 60 s$

热保护型熔断电阻器 (主动控制)

TRXF (Active Protection)

电气特性测试 Electrical Performance Test

项目 Item	测试条件 Test Condition	判定标准 Criterion
可焊性 Solderability	槽焊法 (非活性松香) 助焊剂: 25%松香酒精 锡炉温度: (255 ± 5) °C 浸入深度 (距安装面或元件主体) : (1.5 ~ 2.0) mm 浸入时间: (2.5 ± 0.5) s Solder Bath (non-activated flux) Soldering Powder: 25% Rosin Alcohol Bath Temp.: (255 ± 5) °C Depth of Immersion (From the seating plane or component body): (1.5 to 2.0) mm Time of Immersion: (2.5 ± 0.5) s	引线焊锡面积覆盖率≥95% Soldering Area ≥ 95%
实测熔断温度 Fusing Temp.	产品置于油池, 通10 mA以下的负载电流, 每分钟升温 0.3 °C ~ 0.5 °C, 测断开温度。 Silicone oil bath: temp. rise rate is 0.3 °C/minute to 0.5 °C/ minute, detection current ≤ 10 mA.	143 °C to 147 °C ($T_f = 150 °C$) 138 °C to 142 °C ($T_f = 145 °C$) 128 °C to 132 °C ($T_f = 135 °C$) 123 °C to 127 °C ($T_f = 130 °C$) 119 °C to 123 °C ($T_f = 125 °C$) 109 °C to 113 °C ($T_f = 115 °C$)

热保护型熔断电阻器 (主动控制)

TRXF (Active Protection)

焊接参数 Soldering Parameters

波峰焊参数 (仅供参考) Wave Soldering Parameters (For Reference Only)

波峰焊参数仅供参考，在TRXF实际应用前，推荐进行相关验证。

The Wave Soldering Parameters are for reference only, before TRXF is for practice usage, relative validation is recommended.

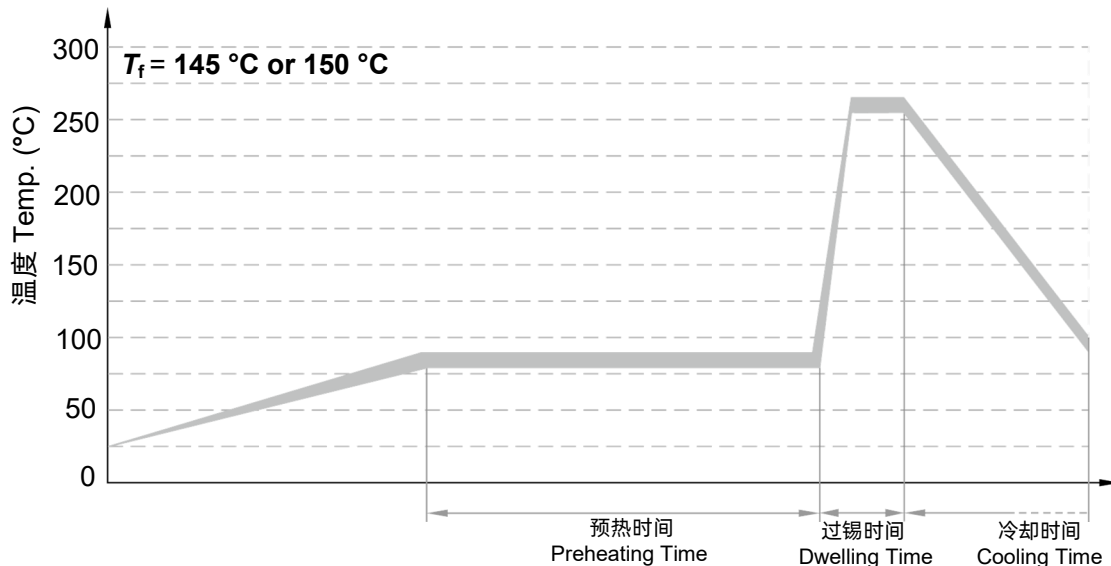

项目 Item	温度 Temp. (°C)	时间 Time (s)
预热 Preheating	80 ~ 90	60 ~ 100
过锡 Dwelling	260 ± 5	4 ~ 5

推荐的手工焊参数 Recommended Hand-Soldering Parameters

烙铁温度 Solder Iron Temp.: (350 ± 5) °C

焊接时间 Soldering Time: 2 s Max. (115 °C ≤ Tf ≤ 150 °C)

热保护型熔断电阻器 (主动控制)

TRXF (Active Protection)



注意

ATTENTION

冷电阻测试 Cold Resistance Test

1. 当产品电阻温度系数 ≥ 350 ($10^{-6}/^{\circ}\text{C}$), 对产品进行电阻测试时, 需要用电阻温度系数将阻值修正至基准温度 25°C 所对应的电阻值。
If product TCR is not less than 350 ($10^{-6}/^{\circ}\text{C}$), the measured resistance value shall be corrected as the relative resistance value under 25°C according to TCR formula.
2. 采用四端测试法
Resistance Measurement (4-terminal test)

更换 Replacement

热保护型熔断电阻器是不可修复的产品, 基于安全原因, 替换时应使用同类别同型号的产品。
As TRXF is a non-resettable product, for safety sake, please use the same type of TRXF for replacement.

使用方法 Usage

1. 通电情况下请勿用人体直接触碰电阻器本体或引脚, 防止烫伤或触电。
Do not touch the resistor body or pins directly when power is on, to avoid burn or electric shock.
2. 气压在 80 kPa 到 106 kPa , 对应海拔为 $+2000\text{ m}$ 到 -500 m 。
When air pressure is from 80 kPa to 106 kPa , the relative altitude shall be $+2000\text{ m}$ to -500 m .

贮存 Storage

1. 将热保护型熔断电阻器放置在温度 10°C ~ 30°C , 相对湿度 30% ~ 75% 的条件下保存。
Please store TRXF with ambient temp. 10°C ~ 30°C and relative humidity 30% ~ 75% .
2. 热保护型熔断电阻器的贮存应避免高温、高湿、日光直射及腐蚀性气体的场合, 避免影响引脚的可焊性, 产品购入后请于1年内使用完毕。
Do not store the TRXF at the high temp., high humidity or corrosive gas environment, avoid influencing the solderability of the pins, please use them up within 1 year after receiving the goods.

热保护型熔断电阻器 (主动控制)

TRXF (Active Protection)

TRXF1 系列 Series

3只脚 Pins



尺寸 Dimensions (mm)

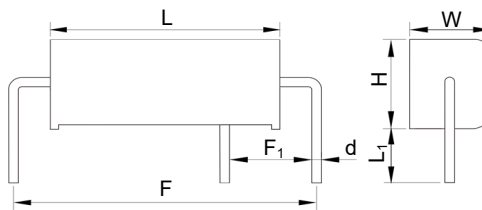

L	L ₁ ^a	W	H	d	F ^a	F ₁
11.5 ± 0.5	3.5 ± 0.5	4.5 Max.	5.0 ± 0.5	Φ0.50 ± 0.05	16.0 ± 1.0	5.0 ± 0.5

^a: “F”, “L₁” 可根据需求定制, 折脚方式亦可定制。 “F”, “L₁” and the bending mode of pins can be customized as required.

4只脚 Pins

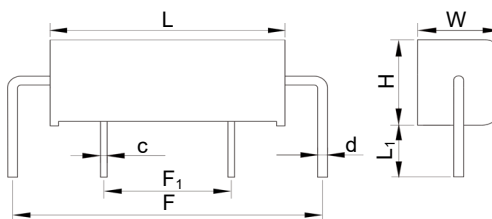

L	L ₁ ^a	W	H	d	c*	F ^a	F ₁
11.5 ± 0.5	3.5 ± 0.5	4.5 Max.	5.0 ± 0.5	Φ0.50 ± 0.05	□0.35 ± 0.10	16.0 ± 1.0	5.0 ± 1.0

^a: “F”, “L₁” 可根据需求定制, 折脚方式亦可定制。 “F”, “L₁” and the bending mode of pins can be customized as required.

c*: 引脚截面为方形。 Cross-section of pin is square.

电性能参数 Electrical Characteristics

项目 Item	参数 Parameter
功率类型 Power Type (P)	1 W
标称阻值 Rated Resistance (R)	1 Ω ~ 600 Ω
阻值公差 Resistance Tolerance	5% (E24) , 10% (E12)
熔断时间 Fusing Time	4 W (115 °C ≤ T _f ≤ 135 °C, 小于60 s, less than 60 s)
	6 W (145 °C ≤ T _f ≤ 150 °C, 小于60 s, less than 60 s)
实测熔断温度 Fusing Temp.	109 °C to 113 °C (T _f = 115 °C)
	119 °C to 123 °C (T _f = 125 °C)
	123 °C to 127 °C (T _f = 130 °C)
	128 °C to 132 °C (T _f = 135 °C)
	138 °C to 142 °C (T _f = 145 °C)
	143 °C to 147 °C (T _f = 150 °C)

热保护型熔断电阻器 (主动控制)

TRXF (Active Protection)

TRXF1 系列 Series

技术参数 Specifications

型号 Model	功率 类型 Power Type	标称阻值 Rated Resistance	阻值公差 Resistance Tolerance	额定动作温度 Rated Functioning Temp. (T _f)	实测熔断 温度 Fusing Temp.	安规认证 Agency Approvals			环保 Environmental Status	
						 cURus	 TUV	 CCC	RoHS	REACH
	(W)	(Ω)	(%)	(°C)	(°C)					
TRXF1-xxxx03FB(SB)	1	0.47 ~ 0.91	±5, ±10	115	109 ~ 113	●	●	N/A	●	●
		1 ~ 600				●	●	●	●	●
TRXF1-xxxx04FB(SB)	1	0.47 ~ 0.91	±5, ±10	125	119 ~ 123	●	●	N/A	●	●
		1 ~ 600				●	●	●	●	●
TRXF1-xxxx05FB(SB)	1	0.47 ~ 0.91	±5, ±10	130	123 ~ 127	●	●	N/A	●	●
		1 ~ 600				●	●	●	●	●
TRXF1-xxxx06FB(SB)	1	0.47 ~ 0.91	±5, ±10	135	128 ~ 132	●	●	N/A	●	●
		1 ~ 600				●	●	●	●	●
TRXF1-xxxx07FB(SB)	1	0.47 ~ 0.91	±5, ±10	145	138 ~ 142	●	●	N/A	●	●
		1 ~ 600				●	●	●	●	●
TRXF1-xxxx08FB(SB)	1	0.47 ~ 0.91	±5, ±10	150	143 ~ 147	●	●	N/A	●	●
		1 ~ 600				●	●	●	●	●

阻值选型表 (参照标准: IEC60063-2015, 蓝色字体为赛尔特常规阻值)

Resistance Selection Table (According to IEC60063-2015, blue font is SETsafe | SETfuse common resistance)

标称阻值 Rated Resistance	代码 Code	标称阻值 Rated Resistance	代码 Code	标称阻值 Rated Resistance	代码 Code	标称阻值 Rated Resistance	代码 Code
(Ω)		(Ω)		(Ω)		(Ω)	
0.10	R10	1.0	1R0	10	10R	100	100R
0.11	R11	1.1	1R1	11	11R	110	110R
0.12	R12	1.2	1R2	12	12R	120	120R
0.13	R13	1.3	1R3	13	13R	130	130R
0.15	R15	1.5	1R5	15	15R	150	150R
0.16	R16	1.6	1R6	16	16R	160	160R
0.18	R18	1.8	1R8	18	18R	180	180R
0.20	R20	2.0	2R0	20	20R	200	200R
0.22	R22	2.2	2R2	22	22R	220	220R
0.24	R24	2.4	2R4	24	24R	240	240R
0.27	R27	2.7	2R7	27	27R	270	270R
0.30	R30	3.0	3R0	30	30R	300	300R
0.33	R33	3.3	3R3	33	33R	330	330R
0.36	R36	3.6	3R6	36	36R	360	360R
0.39	R39	3.9	3R9	39	39R	390	390R
0.43	R43	4.3	4R3	43	43R	430	430R
0.47	R47	4.7	4R7	47	47R	470	470R
0.51	R51	5.1	5R1	51	51R	510	510R
0.56	R56	5.6	5R6	56	56R	560	560R
0.62	R62	6.2	6R2	62	62R	620	620R
0.68	R68	6.8	6R8	68	68R	680	680R
0.75	R75	7.5	7R5	75	75R	750	750R
0.82	R82	8.2	8R2	82	82R	N/A	N/A
0.91	R91	9.1	9R1	91	91R	N/A	N/A

TRXF

TRXF

热保护型熔断电阻器 (主动控制)

TRXF (Active Protection)

TRXF1 系列 Series

熔断特性曲线 (仅供参考) Fusing Time Curve (For Reference Only)

TRXF 1 W 10 Ω 熔断曲线。

Fusing Time Curve of TRXF 1 W 10 Ω

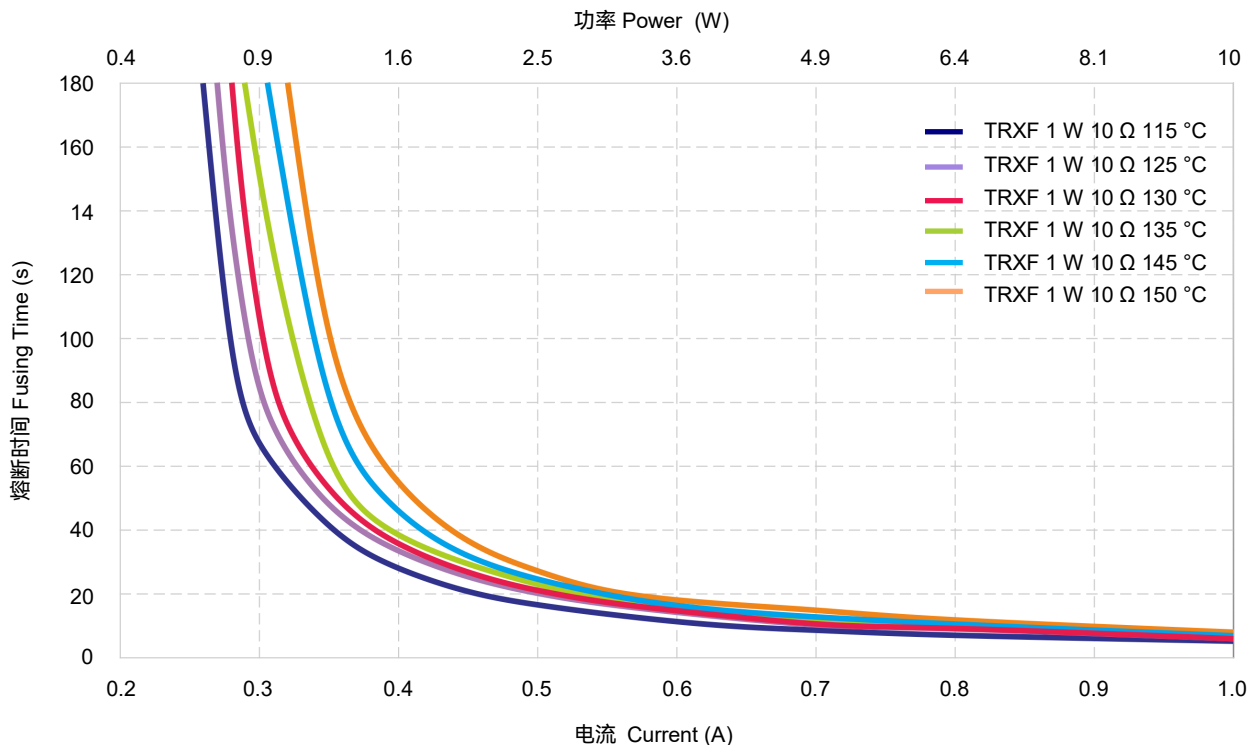

包装信息 Packaging Information

项目 Item	小包装袋 PE Bag	吸塑盘 Tray	外包装箱 Carton
包装尺寸 Dimensions (mm)	135 × 85	475 × 315 × 24.5	495 × 330 × 230
数量 Quantity (PCS)	100	2,000	20,000
毛重 (3只脚) Gross Weight (3 Pins) (kg)			11.5 ± 10%
毛重 (4只脚) Gross Weight (4 Pins) (kg)			12 ± 10%

