

电涌保护器 SPD

Surge Protective Device

过电压 Overvoltage

电力是人类现代生产、生活必不可少的一部分，但电力设施会受到来自内部、外部过电压的威胁，电力系统过电压主要有以下几个方面：

雷电：雷击瞬间会产生很高的能量和高达数百kA的浪涌电流，并且瞬态过电压（LEMP:雷电磁脉冲）会沿电力线路入侵，造成电力设施和用电设备损坏。

操作过电压：一些设备的开关会产生瞬时的过电压。

暂时过电压：主要是持续时间较长（秒级）的工频暂时过电压（不对称接地故障等）和谐振过电压。

Electricity is an essential part of modern human production and life. But power facilities are threatened by internal and external overvoltages. Power system overvoltage mainly includes:

Transient overvoltage of atmospheric origin: Lightning strikes instantly generate high energy, generating surge currents up to hundreds of kA, and lightning wave can invade along power lines, causing damage to power facilities and electrical equipment.

Transient overvoltage due to switching: Switching operations of a power utility may cause overvoltage.

Temporary overvoltage: A long duration (second level) temporary overvoltage (asymmetric ground fault) or harmonious overvoltage.

雷电造成的电涌电压

雷电磁脉冲（LEMP）会危及电气和电子系统，因此应采取LEMP防护措施（SPM）以避免建筑物内电气和电子系统的失效。而雷电磁脉冲产生的浪涌可由直击雷、临近雷击或远处雷击引起。根据相关研究资料表明，一定范围内的雷击都有可能在线缆上产生危险过电压，危害与之相连的设备。

Electrical and electronic system are subject to damage from a lightning electromagnetic impulse (LEMP). Therefore SPM need to be provided avoid failure of internal system. LEMP may caused by direct, near and far lightning strikes. According to the relevant research, lightning strikes within a certain distance may cause dangerous overvoltage on the cable, endangering the equipment connected to it.

雷电的危害 Damage due to lightning

雷电可能产生三种基本的损害类型：

- D1：接触电压和跨步电压使人和动物受到伤害；
- D2：包括有火花的雷电流效应引起的物理损害（火灾、爆炸、机械损坏、化学品泄漏等）；
- D3：LEMP导致内部系统失效。

The lightning can cause three basic type of damage:

- D1: injury to living beings by electric shock
- D2: physical damage (fire, explosion, mechanical destruction, chemical release) due to lightning current effects, including sparking
- D3: failure of internal systems due to LEMP

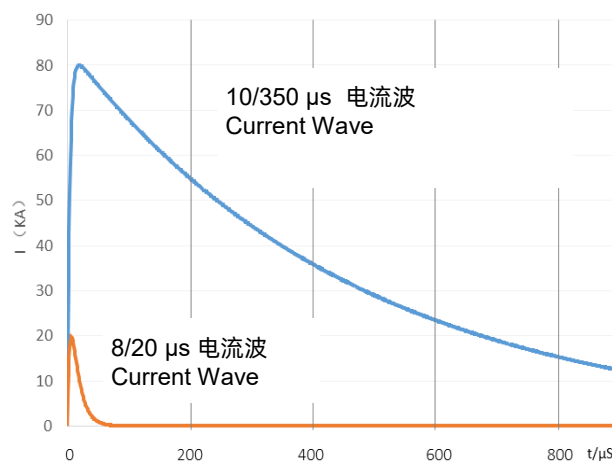

标准雷电测试波形 Standard lightning test wave

电涌保护器 SPD

Surge Protective Device

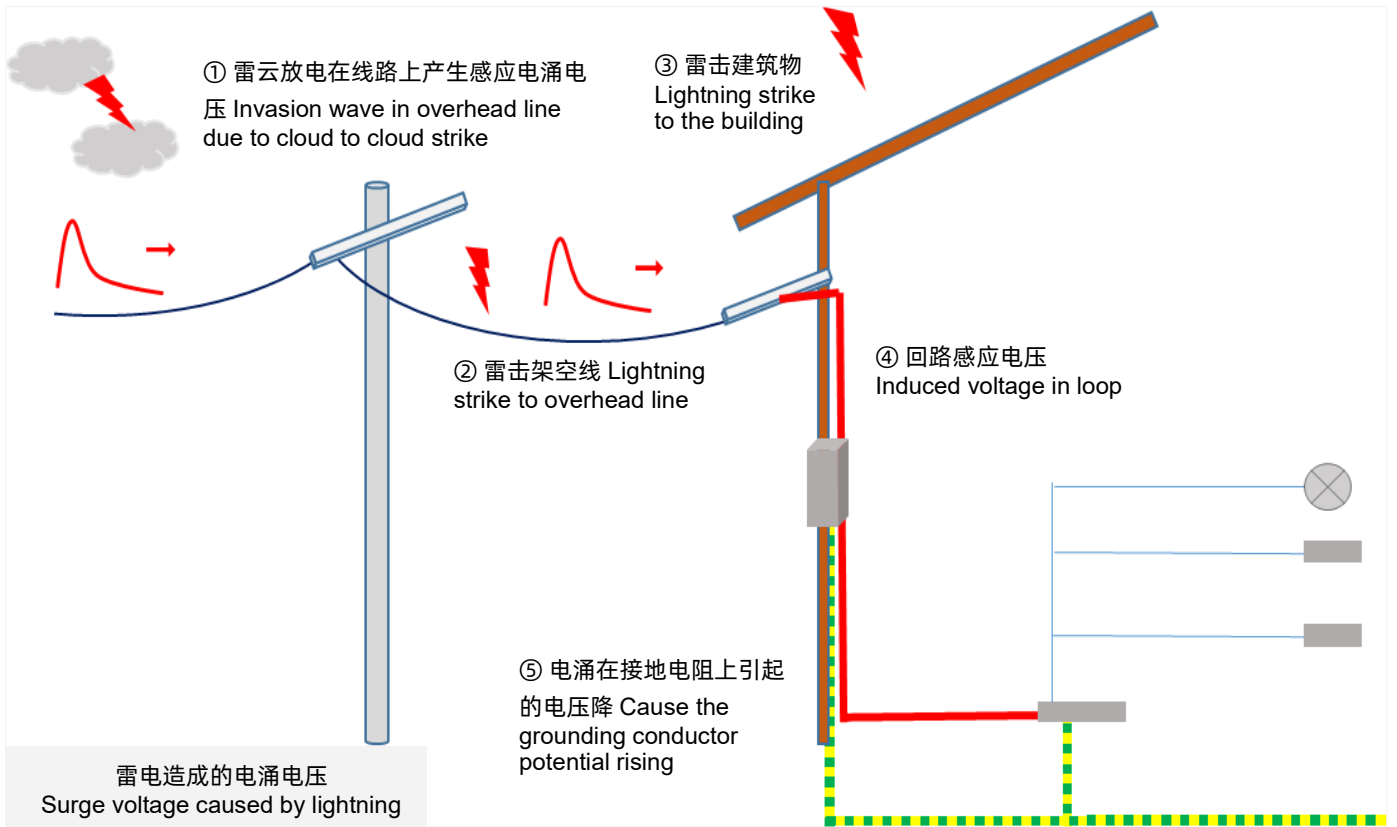

设备耐冲击电压和电涌保护 Impulse withstand voltage and surge protection

SPD作为内部防雷电磁脉冲的主要设备，需要能够承受浪涌冲击电流和提供设备所需的电压保护水平。这涉及到不同位置SPD间的选型和保护配合,从而形成完整的防护措施系统。

As the primary equipment of internal lightning-proof, SPD needs to be able to withstand surge stress and provides the level of voltage protection required for the equipment. This involves the selection and coordination of SPD in different locations to form a complete protection system.

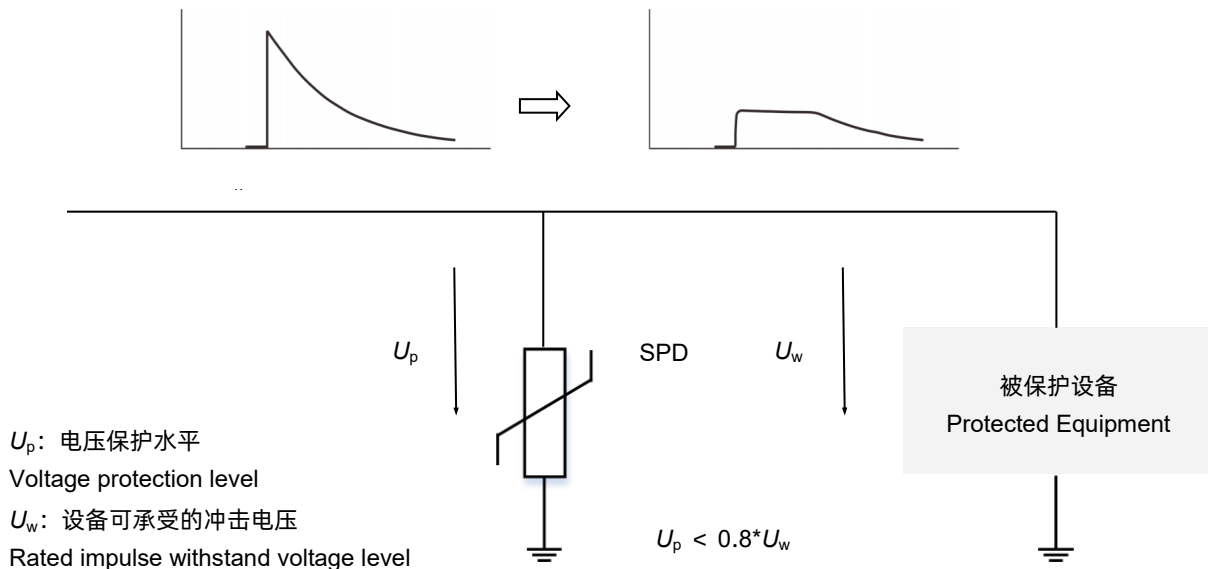

电涌保护器 SPD

Surge Protective Device

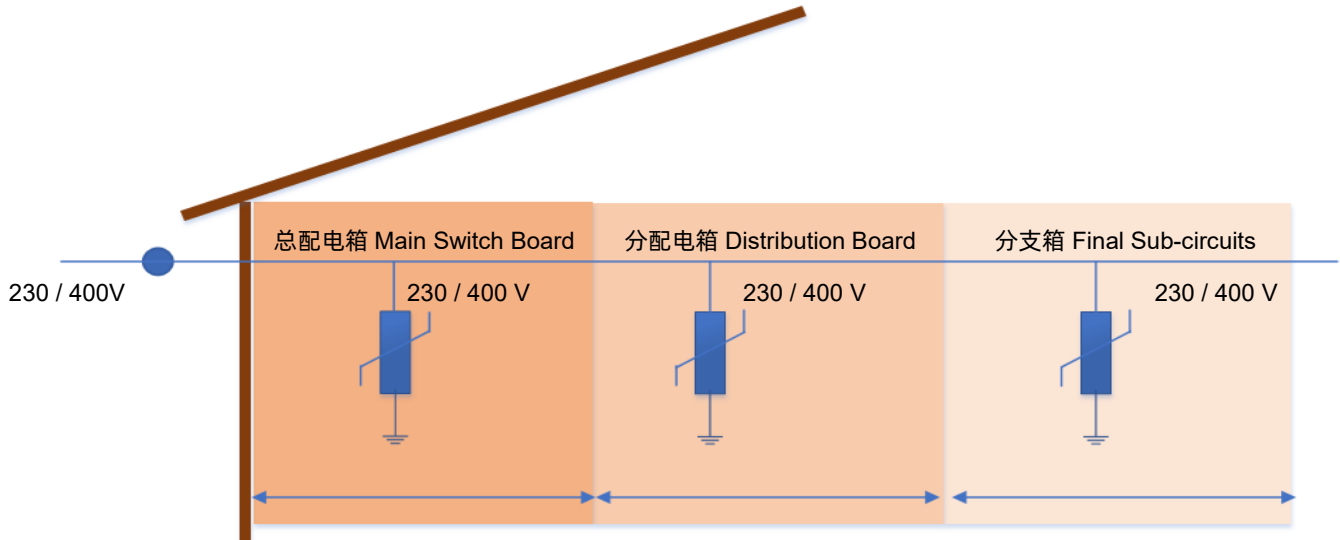

耐冲击电压类别 Overvoltage Category	IV	III	II	I
耐冲击电压 U_w (kV) Impulse Withstand	6	4	2.5	1.5
防雷保护区 Lightning Protection Zone LPZ	LPZ1	LPZ2	LPZn	
SPD类型 Type	Class I or Class II	Class II	Class II or Class III	

SPD

SPD

电涌保护器 SPD

Surge Protective Device

LED 电涌保护器 LED Surge Protective Device

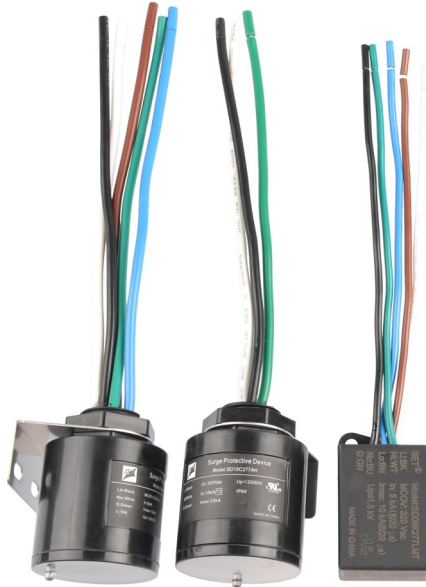

由于LED路灯耐受浪涌的冲击能力较低，LED模块或驱动器在浪涌的冲击下会产生局部或者完全失效。为了确保LED路灯寿命和可靠性，避免不必要的维护，应采用周全的、有效的浪涌保护。

赛尔特（SETsafe | SETfuse）LED 电涌保护器专门为户外照明设计。产品的抗电涌水平符合IEEE C62.41.2 位置类别 C 高暴露等级的要求，保护LED 路灯免受雷电浪涌的损坏。SD10C系列内置热保护，能够在承受持续过电压或者内部压敏电阻劣化时安全失效。

As LEDs are more susceptible to surges, the impact of the surge will cause the partial or complete failure of the LED module or driver. To ensure the service life and reliability and to avoid unnecessary maintenance, a well-conceived and effective surge protection for LED street lightings should be adopted.

SETsafe | SETfuse LED Surge Protective Devices (SPDs) are specifically designed for outdoor lighting. The products facilitate surge immunity compliant with IEEE C62.41.2 Location Category C high exposure and protect LED street lighting from lightning surge damage. With built-in thermal protection, the products could fail safely when suffering sustained overvoltage or its internal varistor degradation. The products with small size, could be easily mounted in narrow space.

特性 Features

- 密封外壳，IP66 Sealed Enclosure, IP66
- 共模和差模保护 Differential and Common Mode Protections
- 一端口或两端口SPD
One-port or Two-port Surge Protective Device (SPD)
- 热保护和失效指示
Thermal Protection and Failure Indication

应用 Applications

- 户外路灯 Outdoor Street Lighting
- 停车场照明灯 Parking Lighting
- 高速路灯 Highway Lighting
- 景观灯 Landscape Lighting
- 交通信号灯 Traffic and Signal Lighting

电涌保护器 SPD

Surge Protective Device

工作原理 Operation Principle

当电路无浪涌时，SPD等效于开路（阻抗 > 100 MΩ）。

SPD is equivalent to open circuit when the circuit without surge (Impedance > 100 MΩ).

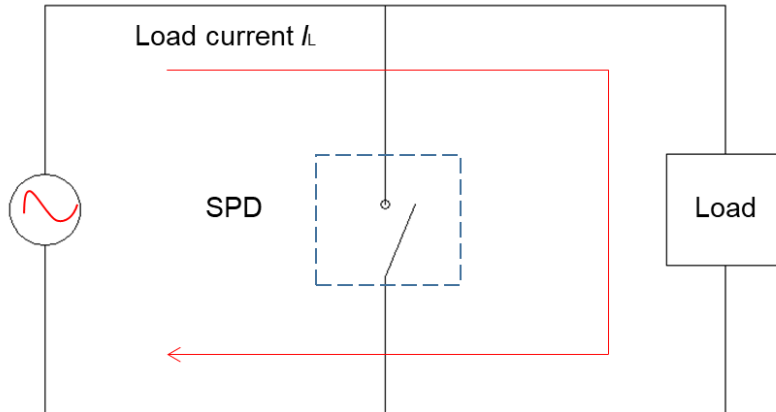

当电路有浪涌入侵时，SPD回路突变为低阻抗，将浪涌泄放到大地中。

When a surge invades the circuit, the SPD circuit mutates to a low impedance, releasing the surge current into the ground.

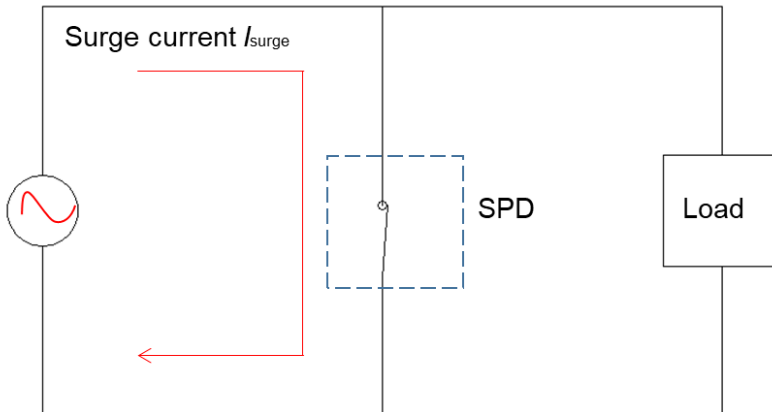

电涌保护器 SPD

Surge Protective Device

术语 Glossary

项目 Item	定义 Description
U_p	<p>电压保护水平 Voltage Protection Level</p> <p>由于施加规定陡度的冲击电压和规定幅值及波形的冲击电流而在SPD两端之间预期出现的最大电压。 Maximum voltage to be expected at the SPD terminals due to an impulse stress with defined voltage steepness and an impulse stress with a discharge current with given amplitude and waveshape.</p> <p>— (IEC 61643-11)</p>
8/20 μ s	<p>8/20 μs 冲击电流 Current Impulse</p> <p>视在波前时间为8μs, 半峰值时间为20μs的冲击电流。 Current impulse with a nominal virtual front time of 8 μs and a nominal time to half-value of 20 μs.</p> <p>— (IEC 61643-11)</p>
1.2/50 μ s	<p>1.2/50 冲击电压 Voltage Impulse</p> <p>视在波前时间为1.2μs, 半峰值时间为50μs 的冲击电压。 Voltage impulse with a nominal virtual front time of 1.2 μs and a nominal time to half-value of 50 μs.</p> <p>— (IEC 61643-11)</p>
U_c	<p>最大持续工作电压 Maximum Continuous Operating Voltage</p> <p>可连续地施加在SPD上的最大交流电压有效值。 Maximum r.m.s. voltage, which may be continuously applied to the SPD's mode of protection.</p> <p>— (IEC 61643-11)</p>
I_n	<p>标称放电电流 Nominal Discharge Current</p> <p>流过SPD具有8/20波形电流的峰值。 Crest value of the current through the SPD having a current waveshape of 8/20.</p> <p>— (IEC 61643-11)</p>
I_{imp}	<p>I 类试验的冲击电流 Impulse Discharge Current for Class I Test</p> <p>I_{imp}由三个参数来定义: 电流峰值 I R peak R、电荷量 Q 和比能量 W/R。 Crest value of a discharge current through the SPD with specified charge transfer Q and specified energy W/R in the specified time.</p> <p>— (IEC 61643-11)</p>
I_{max}	<p>最大放电电流 Max. Discharge Current</p> <p>具有 8/20 波形和制造厂声称幅值的流过SPD电流的峰值。I_{max}等于或大于I_n。 Crest value of a current through the SPD having an 8/20 waveshape and magnitude according to the manufacturers specification. I_{max} is equal to or greater than I_n.</p> <p>— (IEC 61643-11)</p>
Modes of protection	<p>保护模式 Modes of protection</p> <p>在端子间保护保护元件的电流路径, 例如相对相、相对地、相对中线、中线对地。 An intended current path, between terminals that contains protective components, e.g. line-to-line, line-to-earth, line-to-neutral, neutral-to-earth.</p> <p>— (IEC 61643-11)</p>
IP	<p>外壳防护等级 (IP 代码) Degrees of Protection Provided by Enclosure (IP Code)</p> <p>外壳提供的防止触及危险的部件、防止外部的固体异物进入和/或防止水的进入壳内的防护程度。 Classification preceded by the symbol IP indicating the extent of protection provided by an enclosure against access to hazardous parts, against ingress of solid foreign objects and possibly harmful ingress of water.</p>

电涌保护器 SPD

Surge Protective Device

型号说明 Part Numbering System

SD 10 C 277 L M T - D - 001

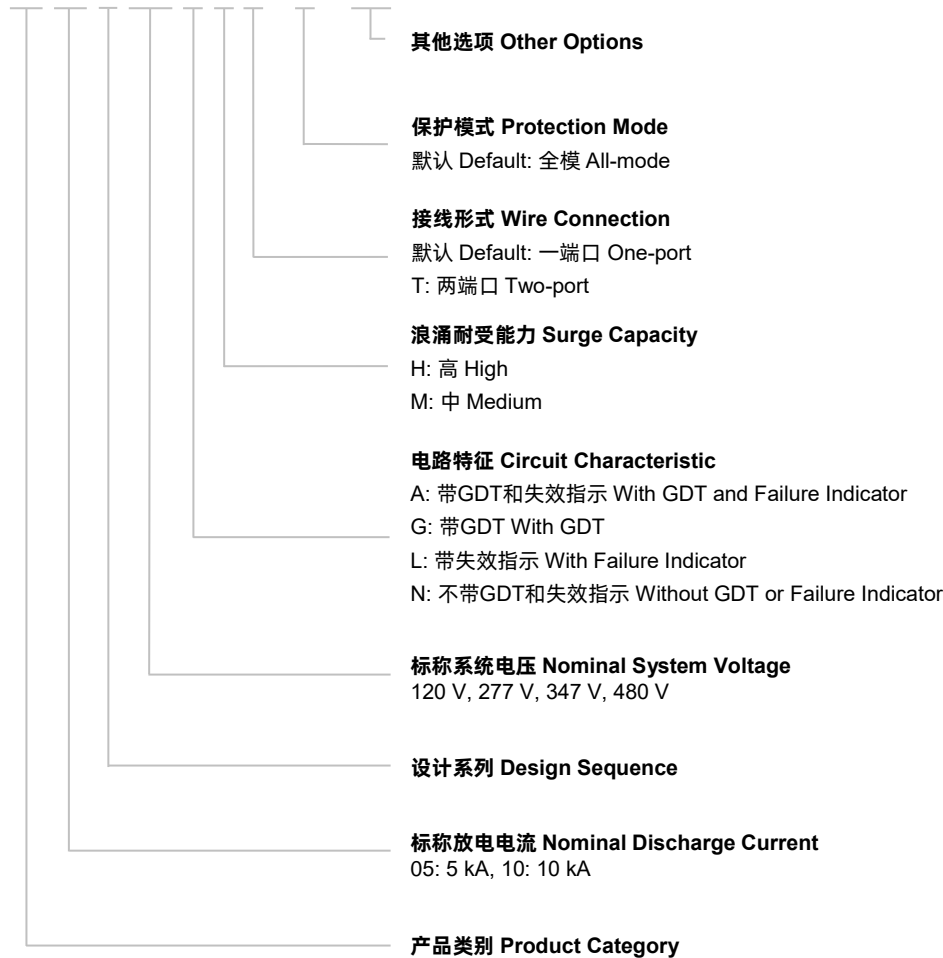

SPD

SPD

认证信息 Agency Information

认证信息 Agency Information	标准 Standards	档案号 NO.	类别 Category
 UL	UL 1449 4th Edition	E322662	VZCA2
 cUL	CSA C22.2 NO.269, CSA ECN 516	E322662	VZCA8
 TUV	IEC/EN 61643-11, IEC/EN 61643-31	详见具体型号 See the different models for details	
 CE	IEC/EN 61643-11, IEC/EN 61643-31	详见具体型号 See the different models for details	
 CB	IEC/EN 61643-11	详见具体型号 See the different models for details	
 CQC	GB/T 18802.1-2011	详见具体型号 See the different models for details	

电涌保护器 SPD

Surge Protective Device



注意

ATTENTION

使用方法 Usage

1. 交流频率在47 Hz和63 Hz之间。
Frequency range is from 47 Hz to 63 Hz a.c.
2. 持续施加在SPD上的电压不应超过其最大连续工作电压 U_c 。
The voltage applied continuously to the SPD can not exceed its maximum continuous operating voltage U_c .
3. 气压在80 kPa 到106 kPa, 对应海拔为+2000 m至- 500 m。
When atmosphere press is from 80 kPa to 106 kPa, the related altitude shall be from +2000 m to -500 m.
4. 通电情况下请勿直接触碰本体或引脚, 防止触电。
Do not touch the product body or pins directly when power is on, to avoid electric shock.

更换 Replacement

基于安全原因, 电涌保护器是不可修复的产品, 替换时应使用同类别同型号的产品。
SPD is a non-repairable product. For safety sake, please use equivalent SPD for replacement.

存贮 Storage

电涌保护器的贮存应避免高温、高湿、日光直射和腐蚀性气体的场合, 避免引线氧化。产品购入后请于2年内使用完。
Please store the SPD without high temperature, high humidity or corrosive gas. To avoid oxidation of the lead wires, please use them up within 2 years after receiving the goods.

电涌保护器 SPD

Surge Protective Device

安装 Installation

1. 仅专业电气人员可进行相关安装和调试。必须遵守相关国家的法规。
Installation and startup may only be carried out by qualified personnel. The relevant country-specific regulations must be observed.
2. 安装前请务必检查设备是否有外部破损。如设备有缺陷，则不得使用。
Check the device for external damage before installation. If the device is defective, it must not be used.
3. 注意触电危险。请在安装使用前断开电源。
Pay attention to risk of electric shock. Please cutoff all electrical power before installation or service.
4. 连接至电涌保护装置（SPD）的输出电缆应尽可能短，避免形成回路。
Lay the output cables to the surge protective devices (SPDs) as short as possible, without loops.
5. 安装过程和安装后不宜对电涌保护器本体施加机械应力。
Do not apply mechanical stress to the SPD body during or after the installation.

维护 Maintenance

1. 每年在雷雨季节的前后根据说明检查SPD的状态。
Check SPD status according to instructions before and after the thunderstorm season each year.
2. 如果出现“故障状态”的指示，则表示SPD损坏。请用相同型号的SPD替换。
If the indicator of "failure state" appears, the SPD is damaged. Replace the SPD with same type.
3. 电路通电前确保电气连接和安装正确。
Ensure electrical connections and mountings are correct before energizing the circuit.
4. 产品在出厂前均经过严格的检验和质量控制，如发现工作异常，请及时与本公司联系
SPD's quality is well controlled and strictly inspected before delivery. If non-functional ones are found during operation, please contact us early enough.

电涌保护器 SPD

Surge Protective Device

户外照明用电涌保护器 SPD for Outdoor Lights



- 户外路灯 Outdoor Street Lighting
- 停车场照明灯 Parking Lighting
- 高速路灯 Highway Lighting
- 景观灯 Landscape Lighting
- 交通信号灯 Traffic and Signal Lighting

电涌保护器 SPD

Surge Protective Device

SD05K 系列 Series

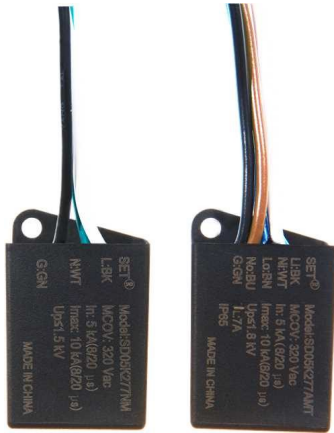

特性 Features

- 密封外壳, IP66 Sealed Enclosure, IP66
- 共模和差模保护
Differential and Common Mode Protections
- 一端口或两端口SPD
One-port or Two-port Surge Protective Device (SPD)
- 热保护和失效指示
Thermal Protection and Failure Indication
- 体积小 Small Size

尺寸 Dimensions (mm)

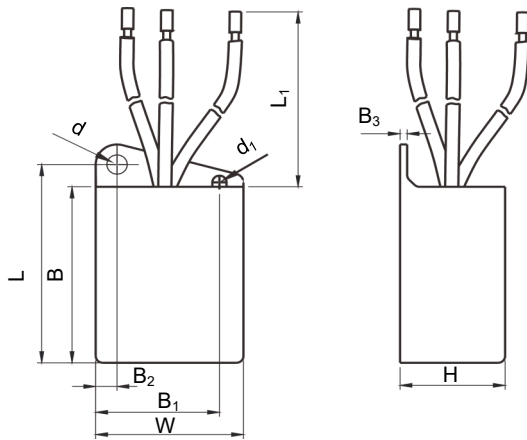

L	L ₁	W	H
44.5 ± 1.0	150.0 ± 5.0	31.0 ± 1.0	22.0 ± 1.0
d	d ₁	B	B ₁
4.3 ± 0.5	3.0 ± 0.5	39.5 ± 1.0	26.0 ± 1.0
B ₂	B ₃		
4.5 ± 0.5	1.5 ± 0.2		

备注: 引线长度 “L₁” 可以根据客户要求定制。
Note: The wire length “L₁” can be customized as required.

产品描述 Description



电涌保护器(SPD) SD05K系列专门为户外照明设计。产品的抗电涌水平符合IEEE C62.41.2 位置类别 C 高暴露等级的要求, 保护LED 路灯免受雷电浪涌的损坏。SD05K系列内置热保护, 能够在承受持续过电压或者内部压敏电阻劣化时安全失效。SD05K系列体积小, 便于在狭小空间内安装。

SD05K series is specifically designed for outdoor lighting. The products facilitate surge immunity compliant with IEEE C62.41.2 Location Category C high exposure and protect LED street lighting from lightning surge damage. With built-in thermal protection, SD05K series could fail safely when suffering sustained overvoltage or its internal varistor degradation. SD05K series with small size, could be easily mounted in narrow space.

应用 Applications

- 户外路灯 Outdoor Street Lighting
- 停车场照明灯 Parking Lighting
- 高速路灯 Highway Lighting
- 景观灯 Landscape Lighting
- 交通信号灯 Traffic and Signal Lighting

认证信息 Approvals Information

机构 Agency	标准 Standards	档案号 No.
 US	UL1449	E322662
 theinland	EN 61643-11	R50434690
	EN 61643-11	AN50473649
环境 Environment	RoHS 2.0 & REACH	符合 Compliant

电涌保护器 SPD

Surge Protective Device

SD10C 系列 Series



产品描述 Description

SD10C 系列专门为户外照明设计。产品的抗电涌水平符合 IEEE C62.41.2 位置类别 C 高暴露等级的要求，保护LED 路灯免受雷电浪涌的损坏。SD10C系列内置热保护，能够在承受持续过电压或者内部压敏电阻劣化时安全失效。

SETsafe | SETfuse surge protective device (SPD) SD10C series is specifically designed for outdoor lighting. The products facilitate surge immunity compliant with IEEE C62.41.2 Location Category C high exposure and protect LED street lighting from lightning surge damage. With built-in thermal protection, SD10C series could fail safely when suffering sustained overvoltage or its internal varistor degradation.

特性 Features

- 密封外壳，IP66 Sealed Enclosure, IP66
- 共模和差模保护 Differential and Common Mode Protections
- 一端口或两端口SPD One-port or Two-port Surge Protective Device (SPD)
- 热保护和失效指示 Thermal Protection and Failure Indication

应用 Applications

- 户外路灯 Outdoor Street Lighting
- 停车场照明灯 Parking Lighting
- 高速路灯 Highway Lighting
- 景观灯 Landscape Lighting
- 交通信号灯 Traffic and Signal Lighting

尺寸 Dimensions (mm)

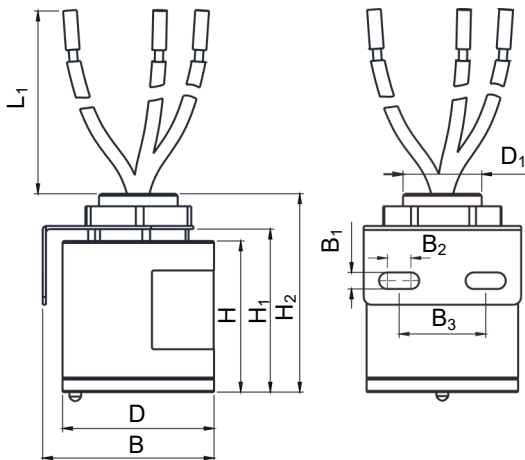

L ₁	H	H ₁	H ₂
150.0 ± 5.0	38.0 ± 1.0	41.0 ± 1.0	50.0 ± 1.0
D	D ₁	B	B ₁
Φ38.0 ± 1.0	M20 × 1.5	43.5 ± 1.0	4.2 ± 0.1
B ₂	B ₃		
6.0 ± 0.1	22.0 ± 0.2		

备注：引线长度 “L₁” 可以根据客户要求定制。

Note: The wire length “L₁” can be customized as required.

电涌保护器 SPD

Surge Protective Device

SD10C 系列 Series

接线图 Wiring Diagram

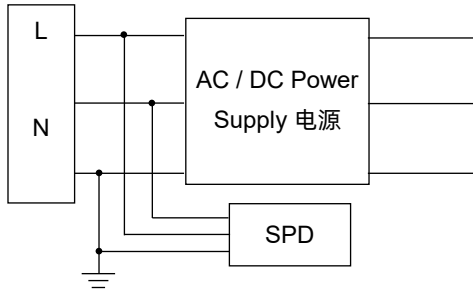

并联（一端口） Parallel Connection (One-port)

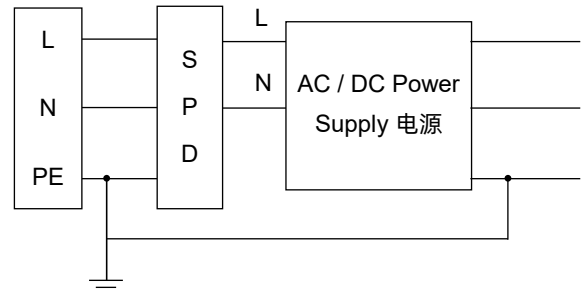

串联（两端口） Series Connection (Two-port)

备注 Notes:

- 1、内部热保护 Internal thermal protection .
- 2、当开路失效发生时，两端口 SPD可以断开主回路

Two-port SPD can disconnect the main line when open-circuit failure happens.

电路原理图 Schematics

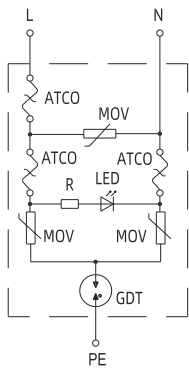

SD10CxxxAx 系列 Series

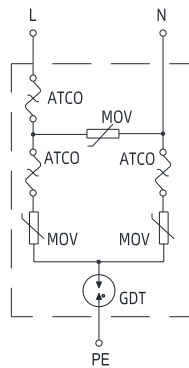

SD10CxxxGx 系列 Series

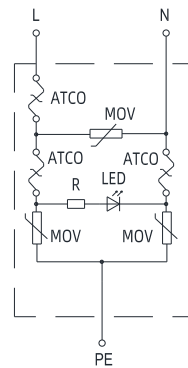

SD10CxxxLx 系列 Series

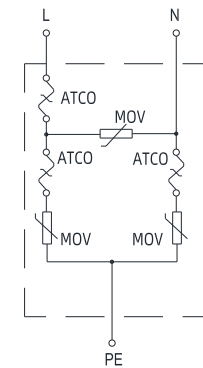

SD10CxxxNx 系列 Series

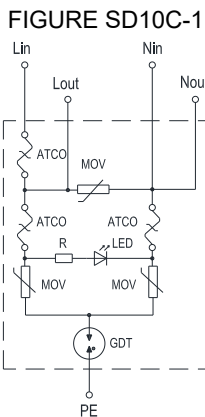

SD10CxxxAxT 系列 Series

FIGURE SD10C-5

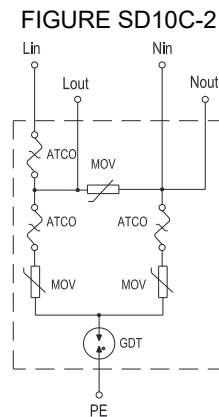

SD10CxxxGxT 系列 Series

FIGURE SD10C-6

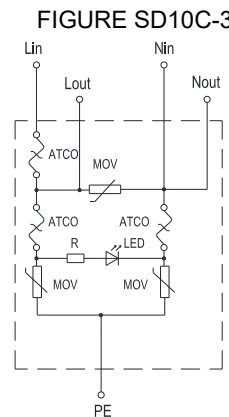

SD10CxxxLxT 系列 Series

FIGURE SD10C-7

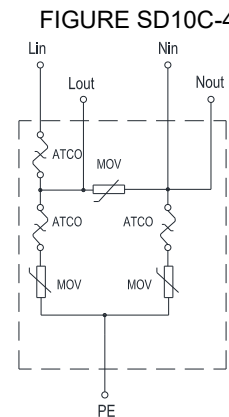



SD10CxxxNxT 系列 Series



FIGURE SD10C-8

备注：引线颜色可以根据相关标准和客户要求定制。

Note: The wire color can be customized according to relevant standards and customer requirements.

认证信息 Approvals Information

机构 Agency	标准 Standards	档案号 No.
	UL1449	E322622
	IEC/EN 61643-11	3183404.02AOC
	IEC 61643-11	NL-41004, NL-41006
环境 Environment	RoHS 2.0 & REACH	符合 Compliant

型号 Model	失效指示 Fault Indicator	GDT	一端口 One-Port	两端口 Two-Port	安规认证 Agency Approvals		
							
SD10C120A*	●	●	●		●	●	
SD10C277A*	●	●	●		●	●	●
SD10C347A*	●	●	●		●	●	
SD10C480A*	●	●	●		●		
SD10C120G*		●	●		●		
SD10C277G*		●	●		●		
SD10C347G*		●	●		●		
SD10C480G*		●	●		●		
SD10C120L*	●		●		●	●	
SD10C277L*	●		●		●	●	●
SD10C347L*	●		●		●	●	
SD10C480L*	●		●		●		
SD10C120N*			●		●		
SD10C277N*			●		●		
SD10C347N*			●		●		
SD10C480N*			●		●		
SD10C120A*T	●	●		●	●	●	
SD10C277A*T	●	●		●	●	●	●
SD10C347A*T	●	●		●	●	●	
SD10C480A*T	●	●		●	●		
SD10C120G*T		●		●	●		
SD10C277G*T		●		●	●		
SD10C347G*T		●		●	●		
SD10C480G*T		●		●	●		
SD10C120L*T	●			●	●	●	
SD10C277L*T	●			●	●	●	●
SD10C347L*T	●			●	●	●	
SD10C480L*T	●			●	●		
SD10C120N*T				●	●		
SD10C277N*T				●	●		
SD10C347N*T				●	●		
SD10C480N*T				●	●		

SPD

SPD

技术参数 Specifications

型号 Model	最大连续 工作电压 Max. Continuous Operating	标称放电 电流 Nominal Discharge Current	最大放电 电流 Max. Discharge Current	电压保护 等级 Voltage Protection Rating	电压保护 水平 Voltage Protection Level	额定电流 Rated Current ^a	响应时间 Response Time	外部过电流 保护 External Overcurrent Protection ^b	电路原理图 Schematic
	U_c	I_n	I_{max}	VPR	U_p	I_r			
	(VAC)	(kA)	(kA)	(V)	(V)	(A)			
SD10C120A*	150	10	15/25	800	1400	-	<100	32	SD10C-1
SD10C277A*	320	10	15/25	1300	2000	-	<100	32	SD10C-1
SD10C347A*	420	10	15/25	1500	2200	-	<100	32	SD10C-1
SD10C480A*	550	10	15/20	1800	3000	-	<100	32	SD10C-1
SD10C120G*	150	10	15/25	800	1400	-	<100	32	SD10C-2
SD10C277G*	320	10	15/25	1300	2000	-	<100	32	SD10C-2
SD10C347G*	420	10	15/25	1500	2200	-	<100	32	SD10C-2
SD10C480G*	550	10	15/20	1800	3000	-	<100	32	SD10C-2
SD10C120L*	150	10	15/25	600	1200	-	<25	32	SD10C-3
SD10C277L*	320	10	15/25	1150	1600	-	<25	32	SD10C-3
SD10C347L*	420	10	15/25	1350	2000	-	<25	32	SD10C-3
SD10C480L*	550	10	15/20	1600	2500	-	<25	32	SD10C-3
SD10C120N*	150	10	15/25	600	1200	-	<25	32	SD10C-4
SD10C277N*	320	10	15/25	1150	1600	-	<25	32	SD10C-4
SD10C347N*	420	10	15/25	1350	2000	-	<25	32	SD10C-4
SD10C480N*	550	10	15/20	1600	2500	-	<25	32	SD10C-4
SD10C120A*T	150	10	15/25	800	1400	15	<100	32	SD10C-5
SD10C277A*T	320	10	15/25	1300	2000	15	<100	32	SD10C-5
SD10C347A*T	420	10	15/25	1500	2200	15	<100	32	SD10C-5
SD10C480A*T	550	10	15/20	1800	3000	15	<100	32	SD10C-5
SD10C120G*T	150	10	15/25	800	1400	15	<100	32	SD10C-6
SD10C277G*T	320	10	15/25	1300	2000	15	<100	32	SD10C-6
SD10C347G*T	420	10	15/25	1500	2200	15	<100	32	SD10C-6
SD10C480G*T	550	10	15/20	1800	3000	15	<100	32	SD10C-6
SD10C120L*T	150	10	15/25	600	1200	15	<25	32	SD10C-7
SD10C277L*T	320	10	15/25	1150	1600	15	<25	32	SD10C-7
SD10C347L*T	420	10	15/25	1350	2000	15	<25	32	SD10C-7
SD10C480L*T	550	10	15/20	1600	2500	15	<25	32	SD10C-7
SD10C120N*T	150	10	15/25	600	1200	15	<25	32	SD10C-8
SD10C277N*T	320	10	15/25	1150	1600	15	<25	32	SD10C-8
SD10C347N*T	420	10	15/25	1350	2000	15	<25	32	SD10C-8
SD10C480N*T	550	10	15/20	1600	2500	15	<25	32	SD10C-8

备注 Notes:

a: 温度保险丝额定电流 Rated Current of the Thermal Fuse

b: 推荐外部断路器型号 C 32 A, C型 Recommended External Circuit Breaker Model: C 32 A, Curve C

包装信息 Packaging Information

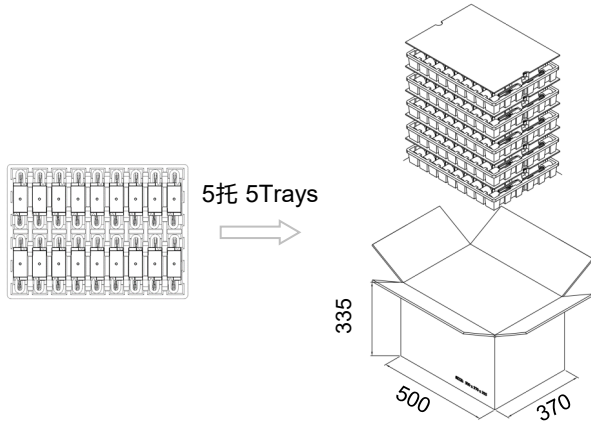

项目 Item	托 Tray	箱 Carton
尺寸 Dimensions (mm)	470 × 350 × 57	500 × 370 × 335
数量 Quantity (PCS)	32	160

单位 Unit: mm

有特殊包装需求请联系我们

Please contact us if you have special packaging requirements.