

描述 Description

1.5KE系列是专为保护敏感电子设备免受雷电和其他瞬变电压事件引起的电压瞬变。

The 1.5KE Series is designed specifically to protect sensitive electronic equipment from voltage transients induced by lightning and other transient voltage events.

应用 Applications

- 通信设备 Communication Equipment
- 安防 Security & Protection
- 工控设备 Industrial Control Equipment
- 电源 Power Supply
- 汽车电子 Automotive Electronics
- 新能源设备 New Energy
- 防雷保护 Lightning Protection

功能图 Functional Diagram

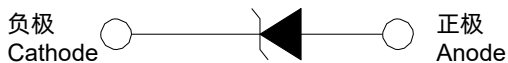

单向 Uni-Directional



双向 Bi-Directional

特性 Features

- 重复率0.01% 的10/1000 μ S 波形对应峰值脉冲功率1500 W
- DO-201封装内置玻璃钝化保护或平面芯片(< 10 V)
- 快速响应时间：从0 V到击穿电压时间小于1.0 PS
- 优异的箝位性能
- 典型的故障模式为电压或电流超过额定而导致的短路
- 锡须测试依据JEDEC JESD201A表4a和4c进行
- IEC 61000-4-2 ESD 30 kV (空气), 30 kV (接触)
- 数据线ESD保护符合IEC 61000-4-2
- 数据线EFT保护符合IEC 61000-4-4
- 低浪涌电阻
- 当 $V_{BR \min} > 12$ V 时, 典型 I_R 小于 1 μ A
- 回流焊高温保证:260 $^{\circ}$ C / 30 S
- 温度系数典型值0.1%
- 密封材料阻燃等级V-0
- 引脚镀雾锡
- 无卤素, 符合RoHS要求
- 无铅E3: 二级互连引线无铅, 端子镀锡(Sn) (IPC/JEDECJ-STD-609A.01)
- 1500 W peak pulse capability at 10/1000 μ S waveform, repetition rate (duty cycles):0.01%
- Glass passivated chip junction or Planar chip (< 10 V) in DO-201 Package
- Fast response time: typically less than 1.0 PS from 0 Volts to BV min
- Excellent clamping capability
- Typical failure mode is short from over-specified voltage or current
- Whisker test is conducted based on JEDEC JESD201A per its table 4a and 4c
- IEC-61000-4-2 ESD 30 kV (Air), 30 kV (Contact)
- ESD protection of data lines in accordance with IEC 61000-4-2
- EFT protection of data lines in accordance with IEC 61000-4-4
- Low incremental surge resistance
- Typical I_R less than 1 μ A when $V_{BR \min} > 12$ V
- High temperature to reflow soldering guaranteed: 260 $^{\circ}$ C/30 sec / 0.375", (9.5 mm) lead length, 5 lbs., (2.3 kg) tension
- $V_{BR} @ T_J = V_{BR@25^{\circ}C} \times (1 + \alpha T \times (T_J - 25))$
(αT : Temperature Coefficient, typical value is 0.1%)
- Plastic package is flammability rated V-0 per Underwriters Laboratories
- Matte tin lead-free plated
- Halogen free and RoHS compliant
- Pb-free E3 means 2nd level interconnect is Pb-free and the terminal finish material is tin(Sn) (IPC/JEDECJ-STD-609A.01)

TVS

TVS

封装尺寸 Package Outline Dimensions (DO-201)

阴极线 Cathode Band
(只适用于单向产品 for uni-directional products only)

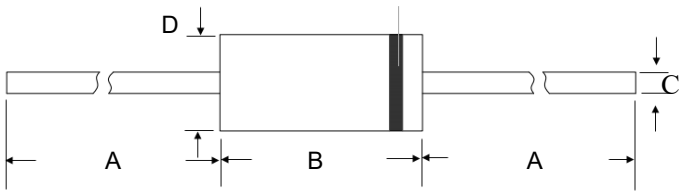

DO - 201

符号 Symbol	公制(毫米) Millimeters		英制(英寸) Inches	
	Min.	Max.	Min.	Max.
A	25.4	-	1.000	-
B	7.20	9.50	0.285	0.375
C	0.96	1.07	0.038	0.042
D	4.80	5.30	0.190	0.210

额定参数与特性 Maximum Ratings and Characteristics

(除另有注释, 默认 $T_A=25\text{ }^\circ\text{C}$ Ratings at $25\text{ }^\circ\text{C}$ ambient temperature unless otherwise specified.)

参数 Parameter	符号 Symbol	值 Value	单位 Unit
10/1000 μS 脉冲波形下, 峰值脉冲功率 ⁽¹⁾ (图2)-单芯片 Peak Pulse Power Dissipation(Fig.2) by 10/1000 us Test Waveform(Fig.4) (Note 1) -Single Die Parts	P_{PPM}	1500	W
10/1000 μS 脉冲波形下, 峰值脉冲功率 ⁽¹⁾ (图2)-叠层芯片 ⁽⁴⁾ Peak Pulse Power Dissipation(Fig.2) by 10/1000 us Test Waveform(Fig.4) (Note 1) -Stacked Die Parts (Note 4)	P_{PPM}	2000	W
峰值功耗,无限散热, $T_L=75\text{ }^\circ\text{C}$ Steady State Power Dissipation on Infinite Heat Sink at $T_L=75\text{ }^\circ\text{C}$	P_D	6.5	W
正向脉冲电流峰值 ⁽²⁾ ,额定负载叠加8.3 ms 单半正弦波测得(JEDEC方法) Peak Forward Surge Current, 8.3 ms Single Half Sine Wave Unidirectional Only (Note 2)	I_{FSM}	200	A
正向瞬态电压峰值 ⁽³⁾ , 单向100 A Maximum Instantaneous Forward Voltage at 100 A for Unidirectional Only (Note 3)	V_F	3.5 / 5.0	V
工作和存储温度范围 Operating Junction and Storage Temperature Range	T_J, T_{STG}	-55 to 175	$^\circ\text{C}$
典型热阻(结至引线) Typical Thermal Resistance Junction to Lead	$R_{\theta JL}$	15	$^\circ\text{C} / \text{W}$
典型热阻(结至环境) Typical Thermal Resistance Junction to Ambient	$R_{\theta JA}$	75	$^\circ\text{C} / \text{W}$

注释 Notes:

- 参照图4非重复性脉冲电流波形, 初始结温 $25\text{ }^\circ\text{C}$ 以图3所示曲线降额(环境温度 $T_A=25\text{ }^\circ\text{C}$)。
Non-repetitive current pulse, per Fig. 4 and derated above T_J (initial)= $25\text{ }^\circ\text{C}$ per Fig. 3.
- 叠加波形为8.3 ms单个半周期正弦波或等幅方波, 最长周期4次/min。
Measured of 8.3 ms single half sine-wave or equivalent square wave, duty cycle=4 pulses per minute maximum.
- $V_F < 3.5\text{ V}$ 为单芯片产品, $V_F < 5.0\text{ V}$ 为双芯片产品。
 $V_F < 3.5\text{ V}$ for single die parts and $V_F < 5.0\text{ V}$ for stacked-die parts.
- 双芯片产品的详细信息, 请参阅电气特性中以*标示的部件编号。
For stacked die component details, please refer to models marked with * in electrical characteristics table.

型号规则 Part Numbering System

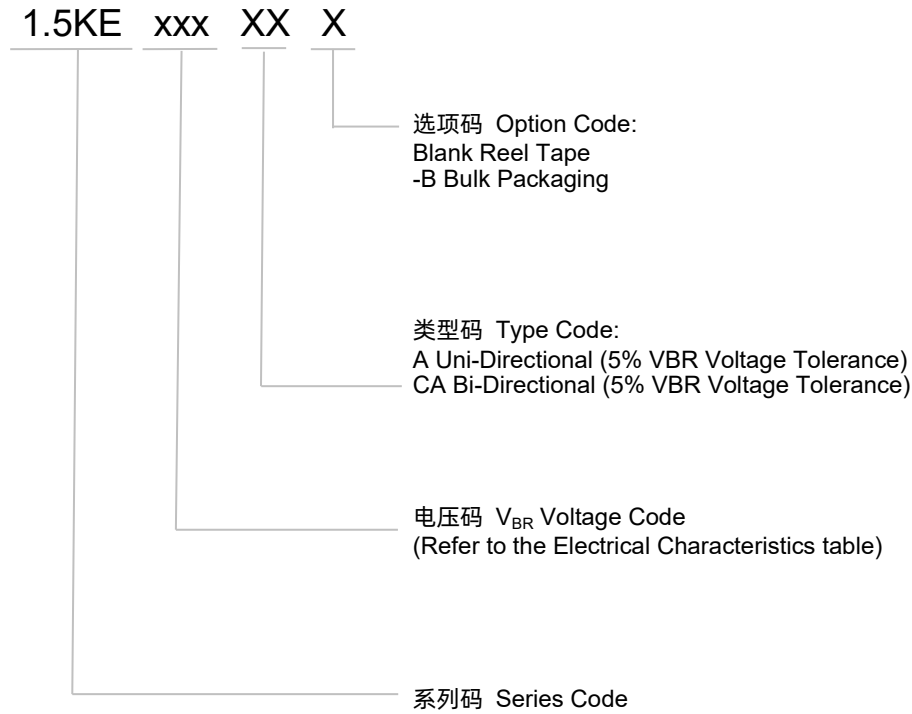

标记 Marking



术语 Glossary

项目 Item	描述 Description
V_C	箝位电压 Clamping Voltage TVS在低差阻区域内的电压，用于限制设备两端的电压。 Voltage across TVS in a region of low differential resistance that serves to limit the voltage across the device terminals.
V_R	反向关断电压 Reverse Stand-off Voltage TVS 在没有导通状态下最高电压。 Maximum voltage that can be applied to the TVS without operation. 注：也用 V_{WM} （最高直流工作电压）表示，也称为截止电压(V_{SO})。 NOTE : It is also shown as V_{WM} (maximum working voltage (maximum d.c. voltage)) and known as rated stand-off voltage (V_{SO}).
I_R	反向漏电流 Reverse Leakage Current 量测 V_R 的电流。 Current measured at V_R . 注：也用 I_D 待机电流表示。 NOTE : Also shown as I_D for stand-by current.
V_{BR}	击穿电压 Breakdown Voltage 在击穿区以指定电流 I_T (测试电流)通过TVS的电压。 Voltage across TVS at a specified current I_T (test current) in the breakdown region.
I_{PPM}	额定随机重复峰值脉冲电流 Rated Random Recurring Peak Impulse Current 施加在设备上的随机重复峰值脉冲电流的最大额定值。 Maximum-rated value of random recurring peak impulse current that may be applied to a device.
$P_{M(AV)}$	额定平均功率 Rated Average Power Dissipation 所有电源(包括瞬态电流和待机电流)在短时间内平均产生的最大额定功耗。 Maximum-rated value of power dissipation resulting from all sources, including transients and standby current, averaged over a short period of time.
P_{PPM}	额定随机重复峰值脉冲功率 Rated Random Recurring Peak Impulse Power Dissipation 额定随机重复峰值脉冲电流(I_{PPM})和规定的最大箝位电压(V_C)乘积的最大额定值。 Maximum-rated value of the product of rated random recurring peak impulse current (I_{PPM}) multiplies by specified maximum clamping voltage (V_C).
C_J	电容 Capacitance 在规定的频率和电压下所测量的TVS电容。 Capacitance across the TVS measured at a specified frequency and voltage.

—(GB-T 18802.321 / IEC 61643-321 / JESD210A)

瞬态抑制二极管 TVS Diodes

Transient Voltage Suppression Diodes

1.5KE Series

项目 Item	描述 Description
V_{FS}	<p>正向浪涌峰值电压 Peak Forward Surge Voltage</p> <p>在指定的正向浪涌电流(I_{FS})和持续时间下, 通过TVS的峰值电压。 Peak voltage across TVS for a specified forward surge current (I_{FS}) and time duration. 注: 也用V_F表示。 NOTE : Also shown as V_F.</p>
I_{FS}	<p>正向浪涌电流 Forward Surge Current</p> <p>在正向导通区域通过TVS的脉冲电流。 Pulsed current through TVS in the forward conducting region. 注: 也用I_F表示。 NOTE : Also shown as I_F.</p>
$\alpha_{V(BR)}$	<p>击穿电压温度系数 Temperature Coefficient of Breakdown Voltage</p> <p>击穿电压的变化与温度变化的比值。 The change of breakdown voltage divided by the change of temperature.</p>
I_{PP}	<p>峰值脉冲电流 Peak pulse Current</p> <p>施加在TVS上的峰值脉冲电流, 以确定箝位电压V_C的特定波形。 Peak pulse current value applied across the TVS to determine the clamping voltage V_C for a specified wave shape.</p>
I_T	<p>脉冲直流测试电流 Pulsed D.C. Test Current</p> <p>测量击穿电压V_{BR}的测试电流。该电流值由制造商确定, 通常以脉冲持续时间小于40 ms的毫安级电流给出。 Test current for measurement of the breakdown voltage V_{BR}. This is defined by the manufacturer and usually given in milliamperes with a pulse duration of less than 40 ms. 注: 也用I_{BR}表示。 NOTE : Also shown as I_{BR}.</p>

—(GB-T 18802.321 / IEC 61643-321 / JESD210A)

电气特性 (除另有注释, 默认 $T_A=25^\circ\text{C}$)Electrical Characteristics ($T_A = 25^\circ\text{C}$ unless otherwise noted) Table 1

型号 Part Number		击穿电压 Breakdown Voltage $V_{BR@I_T}$		测试电流 Test Current I_T	反向关断 电压 Reverse Stand-off Voltage V_R	最大反向 漏电流 Max. Reverse Leakage $I_R@V_R$	最大峰值 脉冲电流 Max. Peak Pulse Current I_{PPM}	最大箝位 电压 Max. Clamping Voltage $V_C@I_{PPM}$
		Min	Max					
Uni	Bi	(V)		(mA)	(V)	(μA)	(A)	(V)
1.5KE6.8A	1.5KE6.8CA	6.45	7.14	10	5.80	1000	144.8	10.5
1.5KE7.5A	1.5KE7.5CA	7.13	7.88	10	6.40	500	134.5	11.3
1.5KE8.2A	1.5KE8.2CA	7.79	8.61	10	7.02	200	125.6	12.1
1.5KE9.1A	1.5KE9.1CA	8.65	9.50	1	7.78	50	113.4	13.4
1.5KE10A	1.5KE10CA	9.50	10.50	1	8.55	10	104.8	14.5
1.5KE11A	1.5KE11CA	10.50	11.60	1	9.40	5	97.4	15.6
1.5KE12A	1.5KE12CA	11.40	12.60	1	10.20	5	91.0	16.7
1.5KE13A	1.5KE13CA	12.40	13.70	1	11.10	1	83.5	18.2
1.5KE15A	1.5KE15CA	14.30	15.80	1	12.80	1	71.7	21.2
1.5KE16A	1.5KE16CA	15.20	16.80	1	13.60	1	67.6	22.5
1.5KE18A	1.5KE18CA	17.10	18.90	1	15.30	1	60.3	25.2
1.5KE20A	1.5KE20CA	19.00	21.00	1	17.10	1	54.9	27.7
1.5KE22A	1.5KE22CA	20.90	23.10	1	18.80	1	49.7	30.6
1.5KE24A	1.5KE24CA	22.80	25.20	1	20.50	1	45.8	33.2
1.5KE27A	1.5KE27CA	25.70	28.40	1	23.10	1	40.5	37.5
1.5KE30A	1.5KE30CA	28.50	31.50	1	25.60	1	36.7	41.4
1.5KE33A	1.5KE33CA	31.40	34.70	1	28.20	1	33.3	45.7
1.5KE36A	1.5KE36CA	34.20	37.80	1	30.80	1	30.5	49.9
1.5KE39A	1.5KE39CA	37.10	41.00	1	33.30	1	28.2	53.9
1.5KE43A	1.5KE43CA	40.90	45.20	1	36.80	1	25.6	59.3
1.5KE47A	1.5KE47CA	44.70	49.40	1	40.20	1	23.5	64.8
1.5KE51A	1.5KE51CA	48.50	53.60	1	43.60	1	21.7	70.1
1.5KE56A	1.5KE56CA	53.20	58.80	1	47.80	1	19.7	77.0
1.5KE62A	1.5KE62CA	58.90	65.10	1	53.00	1	17.9	85.0
1.5KE68A	1.5KE68CA	64.60	71.40	1	58.10	1	16.5	92.0
1.5KE75A	1.5KE75CA	71.30	78.80	1	64.10	1	14.8	103.0
1.5KE82A	1.5KE82CA	77.90	86.10	1	70.10	1	13.5	113.0
1.5KE91A	1.5KE91CA	86.50	95.50	1	77.80	1	12.2	125.0
1.5KE100A	1.5KE100CA	95.00	105.00	1	85.50	1	11.1	137.0
1.5KE110A	1.5KE110CA	105.00	116.00	1	94.00	1	10.0	152.0

瞬态抑制二极管 TVS Diodes

Transient Voltage Suppression Diodes

1.5KE Series

型号 Part Number		击穿电压 Breakdown Voltage $V_{BR@I_T}$		测试电流 Test Current I_T	反向关断 电压 Reverse Stand-off Voltage V_R	最大反向 漏电流 Max. Reverse Leakage $I_R@V_R$	最大峰值 脉冲电流 Max. Peak Pulse Current I_{PPM}	最大箝位 电压 Max. Clamping Voltage $V_C@I_{PPM}$
		Min	Max					
Uni	Bi	(V)		(mA)	(V)	(μ A)	(A)	(V)
1.5KE120A	1.5KE120CA	114.00	126.00	1	102.00	1	9.2	165.0
1.5KE130A	1.5KE130CA	124.00	137.00	1	111.00	1	8.5	179.0
1.5KE150A	1.5KE150CA	143.00	158.00	1	128.00	1	7.3	207.0
1.5KE160A	1.5KE160CA	152.00	168.00	1	136.00	1	6.9	219.0
1.5KE170A	1.5KE170CA	162.00	179.00	1	145.00	1	6.5	234.0
1.5KE180A	1.5KE180CA	171.00	189.00	1	154.00	1	6.2	246.0
1.5KE200A	1.5KE200CA	190.00	210.00	1	171.00	1	5.5	274.0
1.5KE220A	1.5KE220CA	209.00	231.00	1	185.00	1	4.6	328.0
1.5KE250A	-	237.00	263.00	1	214.00	1	4.4	344.0
-	1.5KE250CA*	237.00	263.00	1	214.00	1	5.9	344.0
1.5KE300A*	1.5KE300CA*	285.00	315.00	1	256.00	1	4.9	414.0
1.5KE320A*	1.5KE320CA*	304.00	336.00	1	273.00	1	4.6	441.0
1.5KE350A*	1.5KE350CA*	332.00	368.00	1	300.00	1	4.2	482.0
1.5KE400A*	1.5KE400CA*	380.00	420.00	1	342.00	1	3.7	548.0
1.5KE440A*	1.5KE440CA*	418.00	462.00	1	376.00	1	3.1	602.0
1.5KE480A*	1.5KE480CA*	456.00	504.00	1	408.00	1	3.1	658.0
1.5KE510A*	1.5KE510CA*	485.00	535.00	1	434.00	1	2.9	698.0
1.5KE530A*	1.5KE530CA*	503.50	556.50	1	451.00	1	2.8	725.0
1.5KE540A*	1.5KE540CA*	513.00	567.00	1	460.00	1	2.8	740.0
1.5KE550A*	1.5KE550CA*	522.50	577.50	1	468.00	1	2.7	760.0
1.5KE600A*	1.5KE600CA*	570.00	630.00	1	512.00	1	2.5	828.0

注释 Notes:

1. 叠加波形为8.3 ms单个半周期正弦波或等幅方波，最长周期4次/min。

Measured of 8.3 ms single half sine-wave or equivalent square wave, duty cycle=4 pulses per minute maximum.

2. $V_F < 3.5$ V为单芯片产品， $V_F < 5.0$ V为双芯片产品。 $V_F < 3.5$ V for single die parts and $V_F < 5.0$ V for stacked-die parts.

3. 双芯片产品的详细信息，请参阅电气特性中以*标示的部件编号。

For stacked die component details, please refer to models marked with * in electrical characteristics table.

4. 对于 V_R 为10 V及更低的双向产品， I_R 值需乘以两倍。For bidirectional type having V_R of 10 volts and less, the I_R should be doubled.

伏安特性曲线 I-V Curve Characteristics

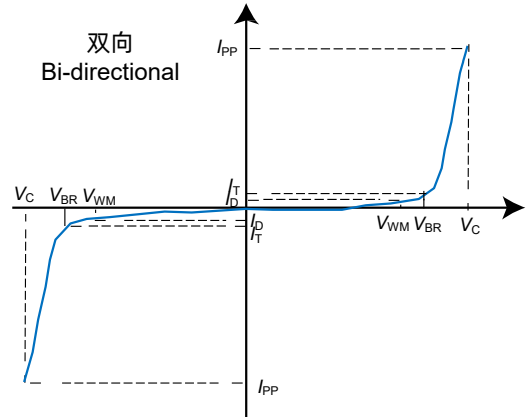
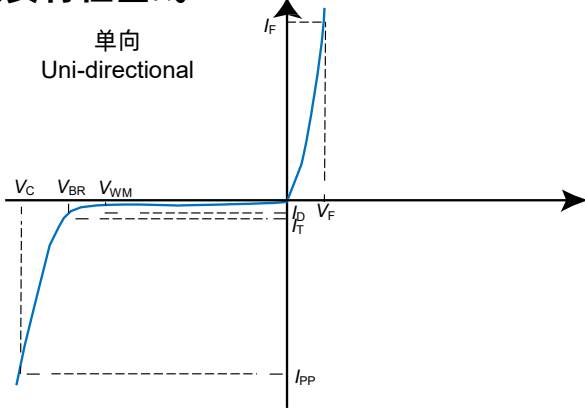

参考性能曲线 (除有另外注释, 默认 $T_A=25^\circ\text{C}$)

Performance Curve for Reference ($T_A=25^\circ\text{C}$ unless otherwise noted)

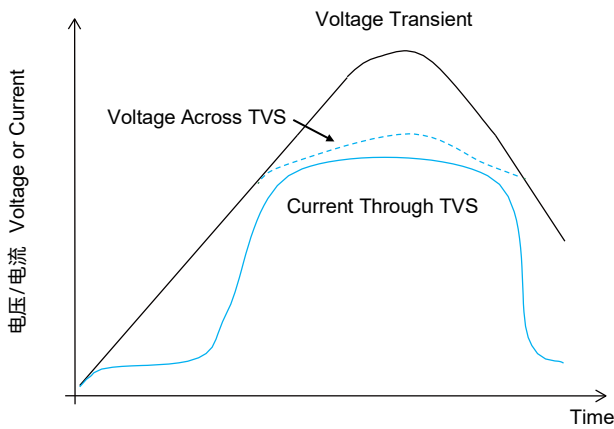

FIGURE 1 TVS瞬态箝位波形
TVS Transients Clamping Waveform

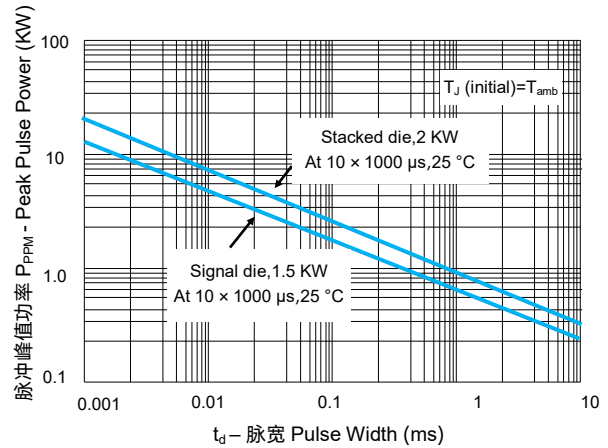

FIGURE 2 峰值脉冲功率额定曲线
Peak Pulse Power Rating Curve

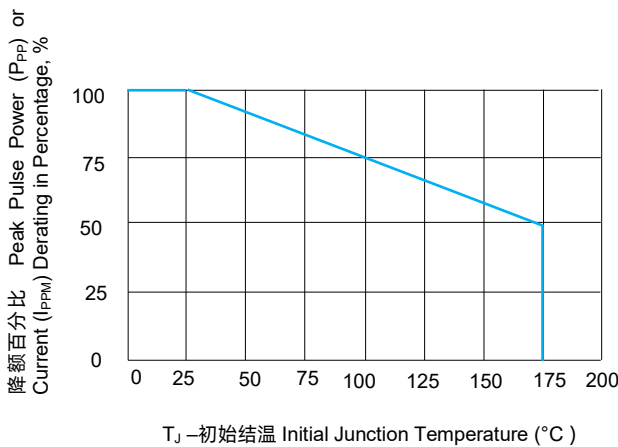

FIGURE 3 峰值脉冲功率降额曲线
Peak Pulse Power Derating Curve

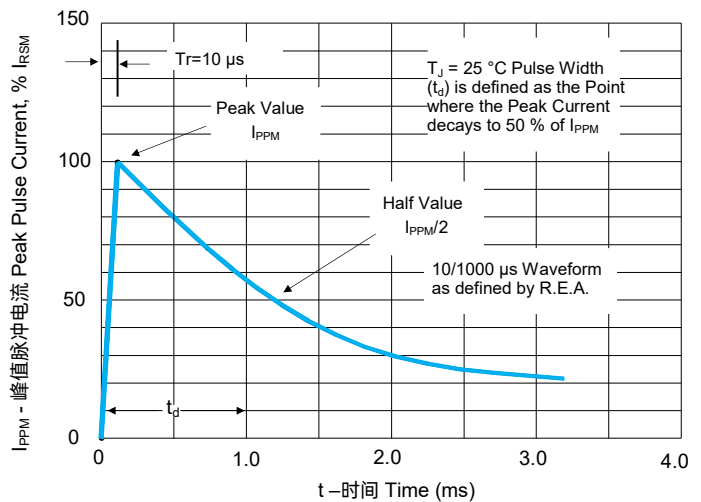

FIGURE 4 脉冲波形
Pulse Waveform

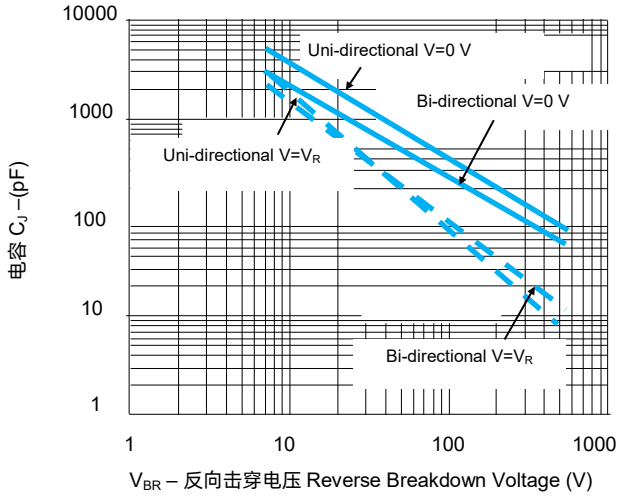

FIGURE 5 典型结电容 Typical Junction Capacitance

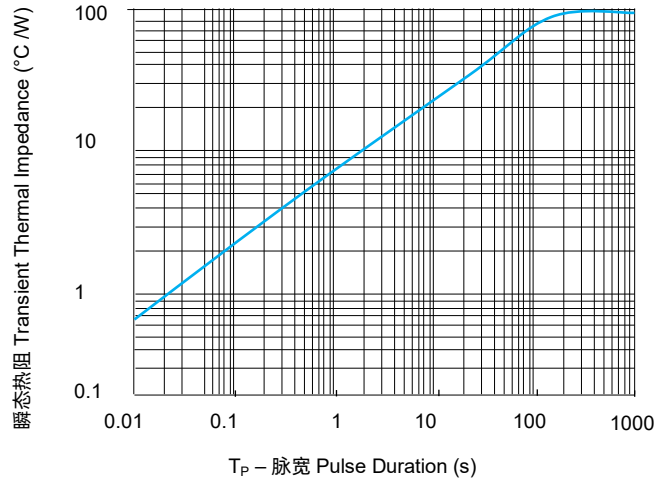

FIGURE 6 典型瞬态热阻 Typical Transient Thermal Impedance

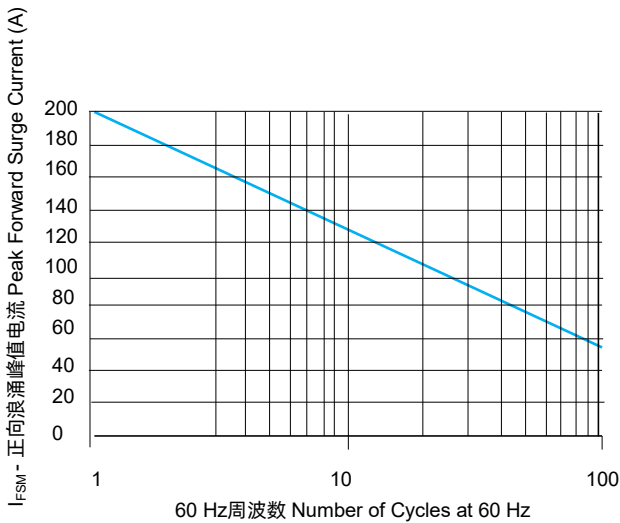

FIGURE 7 最大非重复正向浪涌电流(单向型)
Maximum Non-Repetitive Forward Surge Current
Uni-Directional only

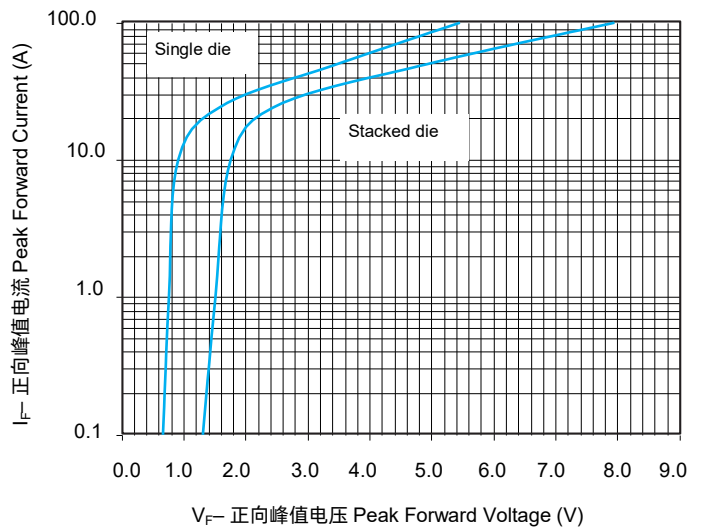

FIGURE 8 峰值正向电压及电流(典型值)
Peak Forward Drop vs Peak Forward Current (Typical Values)

环境特性 Environmental Specifications 物理特性 Physical Specifications

高温存储 High Temp. Storage	JESD22-A103
高温反偏 HTRB	JESD22-A108
温度循环 Temperature Cycling	JESD22-A104
湿度敏感性等级 MSL	JESD22-A101
高温高湿反偏 H3TRB	JESD22-B106
耐焊接热 RSH	

重量 Weight	0.045 oz., 1.2 g
封装 Case	JEDEC DO-201 molded plastic body over passivated junction
极性 Polarity	Color band denotes the cathode except Bipolar.
端子 Terminal	Matte Tin-plated leads, Solderability per JESD22-B102

焊接参数 Soldering Parameters

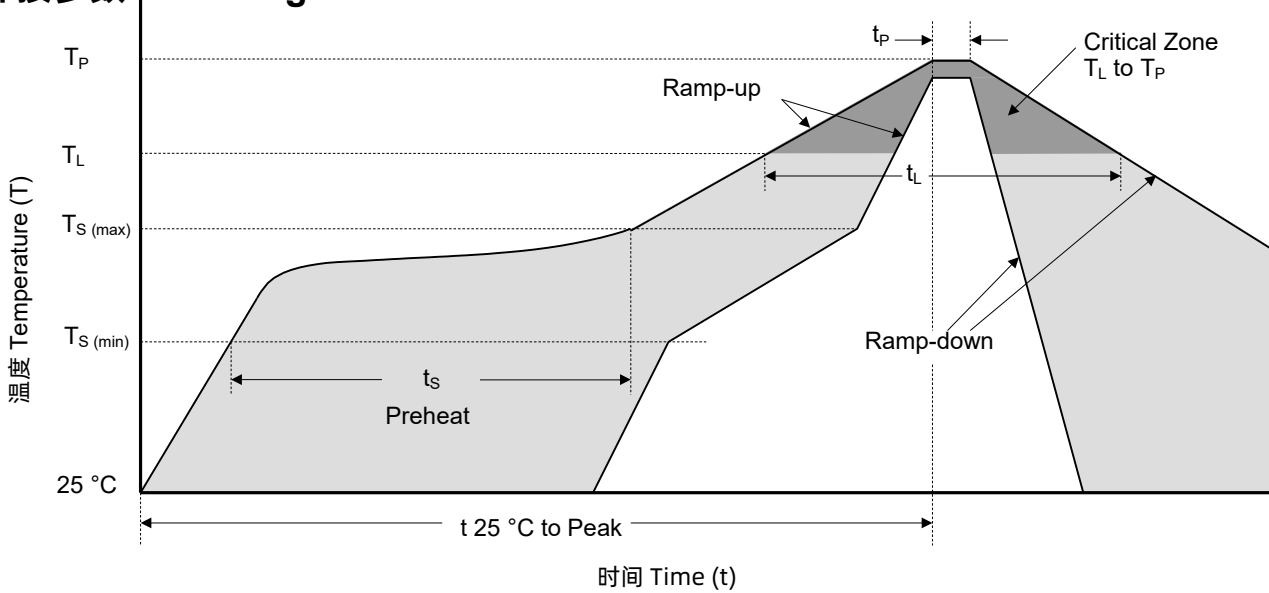

回流焊条件 Reflowing Condition

回流焊接参数 Reflow Soldering Parameters		无铅组装 Lead-Free Assembly
预热 Pre-heat	最低温($T_{S(min)}$) Temperature Min ($T_{S(min)}$)	150 °C
	最高温($T_{S(max)}$) Temperature Max ($T_{S(max)}$)	200 °C
	升温时长(t_s) Time (min to max) (t_s)	60 ~ 120 seconds
平均升温速率(液相温度(T_L)至峰值温度(T_P)) Average Ramp-up Rate (Liquidus Temp (T_L) to Peak Temp (T_P))		3 °C / second max.
$T_{S(max)}$ 到 T_L 升温速率 $T_{S(max)}$ to T_L Ramp-up Rate		3 °C / second max.
回流 Reflow	温度 Temperature (T_L) (Liquidus)	217 °C
	时长 Time (min to max) (t_L)	60 ~ 150 seconds
峰值温度 Peak Temperature (T_P)		260 ^{+0/-5} °C
实际峰值温度 (t_p) 5 °C 以内的时间 Time of within 5 °C of Actual Peak Temperature (t_p)		20 ~ 40 seconds
降温速率 Ramp-down Rate		6 °C / second max.
25 °C 至峰值温度时长 Time from 25 °C to Peak Temperature		8 Minutes max.
极限温度 Do Not Exceed		260 °C

波峰焊(浸焊) Flow/Wave Soldering (Solder Dipping)

峰值温度 Peak Temperature	260 °C+0 /- 5 °C
浸焊时间 Dipping Time	10 seconds
焊接次数 Soldering Number	1 time

包装信息 Packaging Information

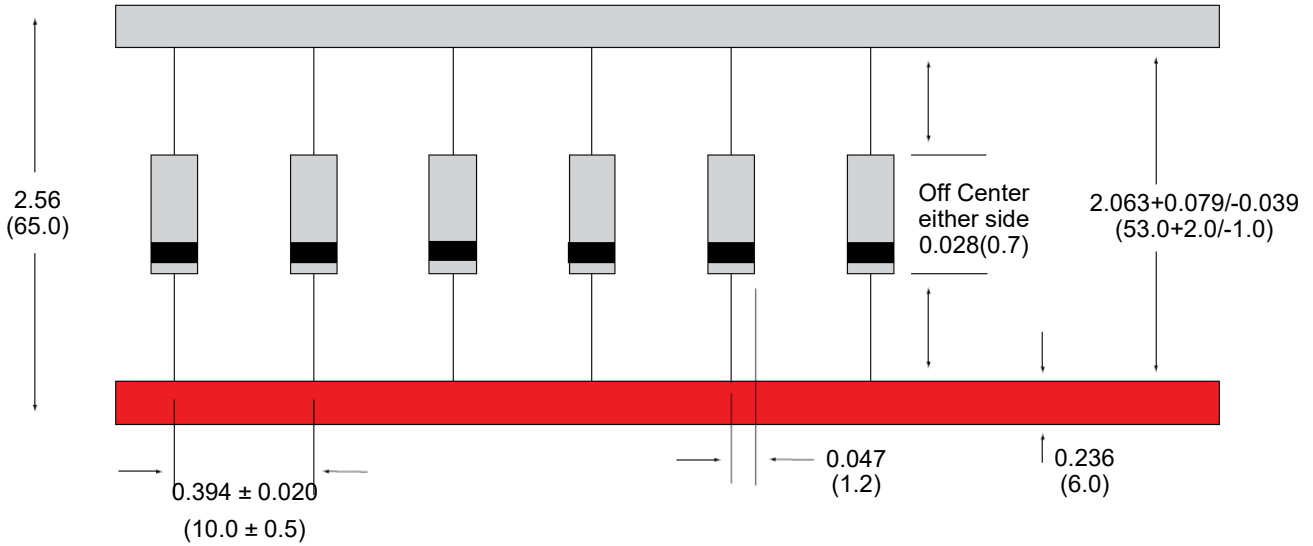

包装信息 Packaging Information

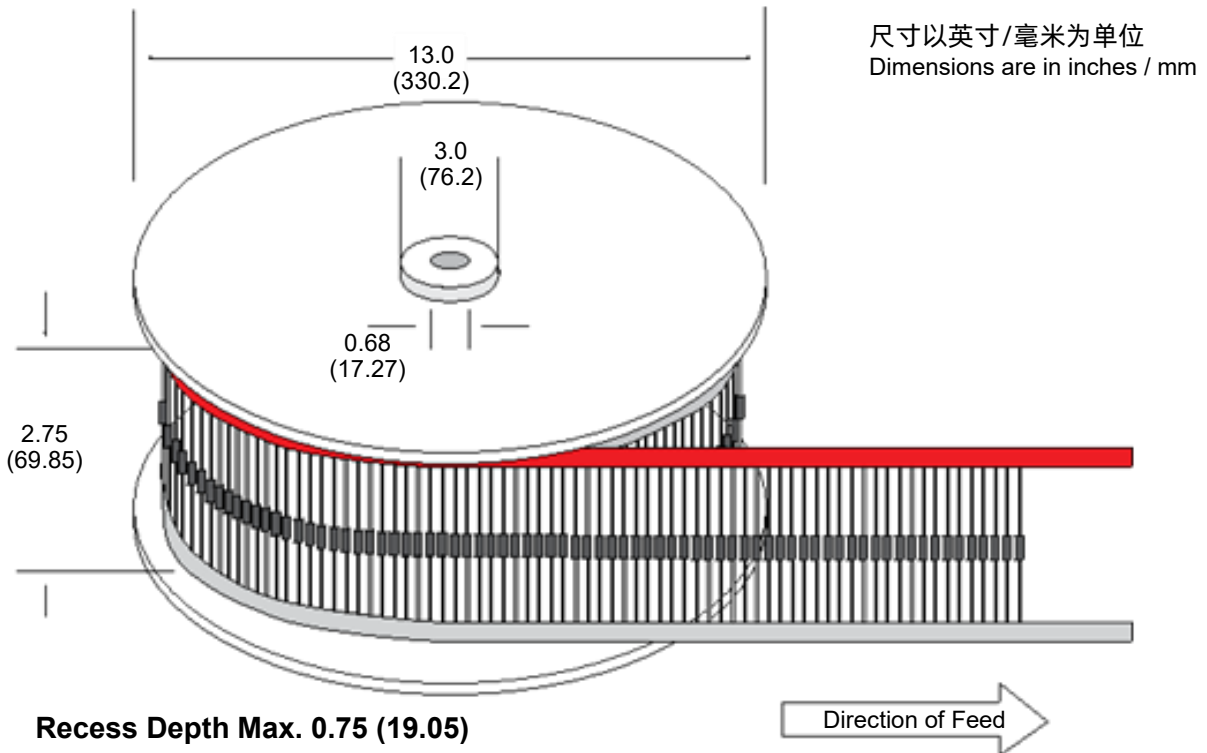

型号 Part Number	封装 Package	数量 QTY' s (Reel)	包装选项 Packaging Option	包装规格 Packaging Specification
1.5KExxxXX	DO-201	1200 PCS	Tape & Reel	EIA STD RS-296
1.5KExxxXX-TB	DO-201	1200 PCS	TB	/
1.5KExxxXX-B	DO-201	500 PCS	BULK	SETsafe SETfuse Spec



注意

ATTENTION

使用方法 Usage

1. 请在规定的温度范围内使用TVS。
TVS must be operated in the specified ambient temp.
2. 请勿使用强极性溶剂清洗TVS以免破坏封装层。
Do not clean the TVS with strong polar solvent such as ketone, esters, benzene and halogenated hydrocarbon, to avoid damaging the encapsulating layer.
3. 请勿对TVS施加剧烈的振动，冲击或压力，以避免元件开裂。
Please do not apply severe vibration, shock or pressure to TVS, to avoid element cracking.

更换 Replacement

1. 若TVS出现可视化损伤，请将其更换。
If TVS is visually damaged, please replace it.
2. TVS为非修理型产品，安全起见，请更换同等规格的TVS。
TVS is a non-repairable product. For safety sake, please use equivalent TVS for replacement.

存储 Storage

1. 存储温度范围。
Storage Temp. Range: (-55 to 150) °C.
2. 请勿将TVS存放于高温高湿或腐蚀性气体环境中，已避免影响引脚的焊接性能，请于收货后一年内进行使用。
Do not store the TVS at the high temp., high humidity or corrosive gas environment, to avoid influencing the solder-ability of the lead wires. The product shall be used up within 1 year after receiving the goods.

环境条件 Environmental Conditions

1. 请勿暴露于室外阳光直射环境。
TVS should not be exposed to the open air, nor direct sunshine.
2. 请避免雨水, 水汽等高温高湿环境。
TVS should avoid rain, water vapor or other condition of high temp. and high humidity.
3. 请避免沙尘, 盐雾等有害环境。
TVS should avoid sand dust, salt mist, or other harmful gases.

TVS最大典型结电容 Max. Typical Capacitance of TVS

高频线路应用中请参照规格书中所给出的典型电容曲线。

The typical capacitance of TVS is listed in the specifications. Designers may refer to it when designing TVS in high frequency circuit.

安装机械应力 Installation Mechanical Stress

1. 安装TVS时请避免敲击, 防止物理损伤。
Do not knock TVS when installing, to avoid mechanical damage.
2. 请不要对 TVS 施加剧烈的振动、冲击或压力, 以免表面树脂或元件破裂。
Please do not apply severe vibration, shock or pressure to TVS, to avoid surface resin or element cracking.