

# 热保护型压敏电阻 TFMOV

Thermal Fuse & MOV

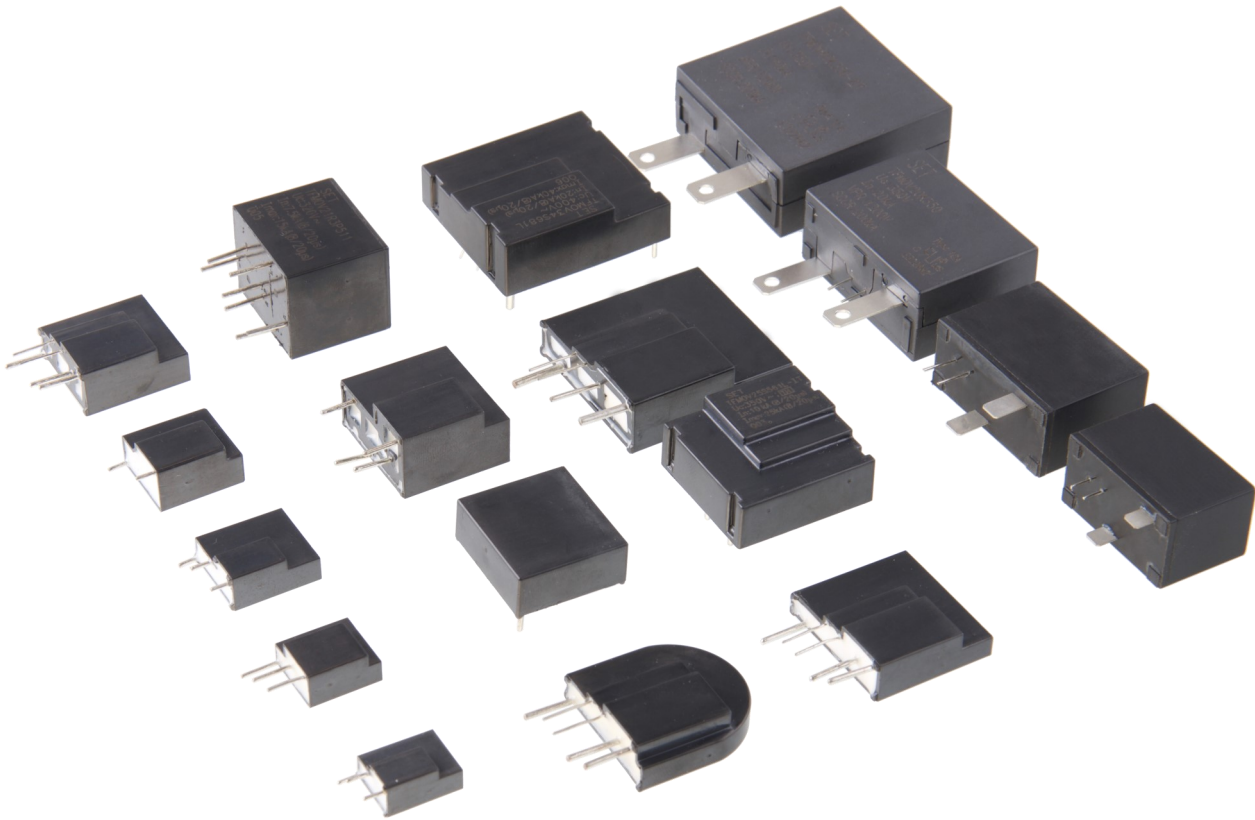

## 特性 Features

- 高可靠性 High Reliability
- 小体积 Small Size
- 失效指示遥信引脚(可选)  
Remote Signal Contact for Failure Indication (Optional)
- 高通流量 High Energy Capacity
- 密封材料阻燃等级V0  
Sealing Material, Flame-retardant to V0 (UL 94)
- 依据 UL 1449 / IEC 61643-11 设计制造  
Comply with UL 1449 / IEC 61643-11

## 应用 Applications

- 通信设备 Telecom Equipment
- 组串逆变器 String Inverter in Photovoltaic System
- 交直流电源 AC / DC Power Supply
- 不间断电源 Uninterruptable Power Supply (UPS)
- 电涌保护器 Surge Protective Device (SPD)
- 电表 Electric Meter
- 电源分配单元 Power Distribution Unit (PDU)

热保护型压敏电阻特性与型号概览  
Thermal Fuse & MOV (TFMOV) Feature & Model List Overview

额定电压 $U_n$ (V)		型号 Model										最大连续工作电压 $U_n$ (V)	
AC	DC	1	1.5	2.5	3	4	5	AC	DC	Page	Page		
690V	600V	○	○	○	○	○	○	○	○	750	1000		
		○	○	○	○	○	○	○	○	680	895		
480V		○	○	○	○	○	○	○	○	625	825		
	400V	○	○	○	TFMOV10S821	○	TFMOV15S821	○	○	510	670		
347V		○	○	○	TFMOV10S751	○	TFMOV15S751	○	○	460	615		
	254	○	○	○	TFMOV10S681	○	TFMOV15S681	○	○	420	560		
	277V	○	○	○	TFMOV10S621	○	TFMOV15S621	○	○	385	505		
220	230V	○	○	○	TFMOV10S561	○	TFMOV15S561	○	○	350	460		
	300V	○	○	○	TFMOV10S511	○	TFMOV15S511	○	○	320	415		
		○	○	○	TFMOV10S471	○	TFMOV15S471	○	○	300	385		
		○	○	○	TFMOV10S431	○	TFMOV15S431	○	○	275	350		
	120	○	○	○	TFMOV10S391	○	TFMOV15S391	○	○	250	320		
	130V	○	○	○	TFMOV10S361	○	TFMOV15S361	○	○	230	300		
		○	○	○	TFMOV10S331	○	TFMOV15S331	○	○	210	275		
		○	○	○	TFMOV10S301	○	TFMOV15S301	○	○	190	250		
		○	○	○	TFMOV10S271	○	TFMOV15S271	○	○	175	225		
110V	110V	○	○	○	TFMOV10S241	○	TFMOV15S241	○	○	150	200		
		○	○	○	TFMOV10S221	○	TFMOV15S221	○	○	140	180		
		○	○	○	TFMOV10S201	○	TFMOV15S201	○	○	130	170		
		○	○	○	TFMOV10S181	○	TFMOV15S181	TFMOV20S181	○	115	150		
	60V	○	○	TFMOV20S680Lx	TFMOV10S151	○	TFMOV15S151	TFMOV20S151	○	95	125		
48V	60V	○	TFMOV10S121	TFMOV15S121	TFMOV20S560Lx	○	TFMOV20S121Lx	○	TFMOV20S121x	75	100		
	48V	○	TFMOV10S101	TFMOV15S101	TFMOV20S470Lx	○	TFMOV20S101Lx	○	TFMOV20S101x	60	85		
	36V	○	TFMOV10S820	TFMOV15S820	○	○	TFMOV20S820Lx	○	TFMOV20S820x	50	65		
		TFMOV10S680	TFMOV15S680	TFMOV20S680x	○	TFMOV25D680x	○	○	TFMOV25S680x	TFMOV25S680Lx	40	56	
24V	24V	TFMOV10S560	TFMOV15S560	TFMOV20S560x	○	TFMOV25D560x	○	○	TFMOV25S560x	TFMOV25S560Lx	35	45	
		TFMOV10S470	TFMOV15S470	TFMOV20S470x	○	○	TFMOV25S470Lx	○	○	○	30	38	
		TFMOV10S390	TFMOV15S390	○	○	○	○	○	○	○	25	31	
12V	12V	TFMOV10S330	TFMOV15S330	○	○	○	○	○	○	○	20	26	
		TFMOV10S270	TFMOV15S270	○	○	○	○	○	○	○	17	22	

标称放电电流 Nominal Discharge Current  $I_n$  (kA)

热保护型压敏电阻特性与型号概览  
Thermal Fuse & MOV (TFMOV) Feature & Model List Overview

额定电压 Rated Voltage $U_n$ (V)		型号 Model										最大连续工作电压 Maximum Continuous Operating Voltage $U_n$ (V)		页码 Page		
AC	DC	7.5		8		10		10 $I_{max} = 2.5I_n$		10		15		AC	DC	
690V	600V	TFMOV20S122x						TFMOV25D122x	TFMOV25S122x					750	1000	
		TFMOV20S112x						TFMOV25D112x	TFMOV25S112x					680	895	
480V	400V	TFMOV20S102x						TFMOV25D102x	TFMOV25S102x					625	825	
		TFMOV20S911x						TFMOV25D911x	TFMOV25S911x					550	745	
347V	254 - 277V	TFMOV20S821x						TFMOV25D821x	TFMOV25S821x					510	670	
		TFMOV20S751x						TFMOV25D751x	TFMOV25S751x					460	615	
220 - 230V	120 - 130V	TFMOV20S681x	TFMOV20S681Lx					TFMOV25D681x	TFMOV25S681x	TFMOV25S681Lx				420	560	
		TFMOV20S621x	TFMOV20S621Lx					TFMOV25D621x	TFMOV25S621x	TFMOV25S621Lx				385	505	
110V	60V	TFMOV20S561x	TFMOV20S561Lx					TFMOV25D561x	TFMOV25S561x	TFMOV25S561Lx				350	460	
		TFMOV20S511x	TFMOV20S511Lx					TFMOV25D511x	TFMOV25S511x	TFMOV25S511Lx				320	415	
48V	36V	TFMOV20S471x	TFMOV20S471Lx					TFMOV25D471x	TFMOV25S471x	TFMOV25S471Lx				300	385	
		TFMOV20S431x	TFMOV20S431Lx					TFMOV25D431x	TFMOV25S431x	TFMOV25S431Lx				275	350	
24V	12V	TFMOV20S391x	TFMOV20S391Lx					TFMOV25D391x	TFMOV25S391x	TFMOV25S391Lx				250	320	
		TFMOV20S361x	TFMOV20S361Lx					TFMOV25D361x	TFMOV25S361x	TFMOV25S361Lx				230	300	
12V	60V	TFMOV20S331x	TFMOV20S331Lx					TFMOV25D331x	TFMOV25S331x	TFMOV25S331Lx				210	275	
		TFMOV20S301x	TFMOV20S301Lx					TFMOV25D301x	TFMOV25S301x	TFMOV25S301Lx				190	250	
48V	36V	TFMOV20S271x	TFMOV20S271Lx					TFMOV25D271x	TFMOV25S271x	TFMOV25S271Lx				175	225	
		TFMOV20S241x	TFMOV20S241Lx					TFMOV25D241x	TFMOV25S241x	TFMOV25S241Lx				150	200	
24V	12V	TFMOV20S221x	TFMOV20S221Lx					TFMOV25D221x	TFMOV25S221x	TFMOV25S221Lx				140	180	
		TFMOV20S201x	TFMOV20S201Lx					TFMOV25D201x	TFMOV25S201x	TFMOV25S201Lx				130	170	
48V	36V			TFMOV25S181x	TFMOV25S181Lx								TFMOV20K181x	115	150	
				TFMOV25S151x	TFMOV25S151Lx								TFMOV20K151x	95	125	
24V	12V			TFMOV25S121x	TFMOV25S121Lx								TFMOV34S121x	75	100	
				TFMOV25S101x	TFMOV25S101Lx							TFMOV34S680Lx	TFMOV34S101x	60	85	
12V	60V			TFMOV25S820x	TFMOV25S820Lx							TFMOV34S560Lx	TFMOV34S820x	50	65	
								TFMOV34S680x				TFMOV34S470Lx		40	56	
12V	60V							TFMOV34S560x						35	45	
								TFMOV34S470x						30	38	
12V	60V													25	31	
														20	26	
12V	60V													17	22	

热保护型压敏电阻特性与型号概览  
Thermal Fuse & MOV (TFMOV) Feature & Model List Overview

额定电压 $U_n$ (V)			型号 Model							最大连续工作电压 Maximum Continuous Operating Voltage $U_n$ (V)		页码 Page	
690V	600V		○	TFMOV20K122x	○	TFMOV34S122x	○	○	TFMOV40K122x	○	750	1000	
			○	TFMOV20K112x	○	TFMOV34S112x	○	○	TFMOV40K112x	○	680	895	
480V	400V		○	TFMOV20K102x	○	TFMOV34S102x	○	○	TFMOV40K102x	○	625	825	
			○	TFMOV20K911x	TFMOV20K550x	TFMOV34S911x	○	○	TFMOV40K911x	TFMOV40K550x	550	745	
347V	254 - 277V		○	TFMOV20K821x	○	TFMOV34S821x	○	○	TFMOV40K821x	○	510	670	
			○	TFMOV20K751x	TFMOV20K460x	TFMOV34S751x	○	○	TFMOV40K751x	TFMOV40K460x	460	615	
220 - 230V	300V		○	TFMOV20K681x	○	TFMOV34S681x	TFMOV34S681Lx	○	TFMOV40K681x	○	420	560	
			○	TFMOV20K621x	○	TFMOV34S621x	TFMOV34S621Lx	○	TFMOV40K621x	○	385	505	
120 - 130V	220V		○	TFMOV20K561x	TFMOV20K350x	TFMOV34S561x	TFMOV34S561Lx	○	TFMOV40K561x	TFMOV40K350x	350	460	
			○	TFMOV20K511x	○	TFMOV34S511x	TFMOV34S511Lx	○	TFMOV40K511x	○	320	415	
110V	110V		○	TFMOV20K471x	○	TFMOV34S471x	TFMOV34S471Lx	○	TFMOV40K471x	○	300	385	
			○	TFMOV20K431x	TFMOV20K300x	TFMOV34S431x	TFMOV34S431Lx	○	TFMOV40K431x	TFMOV40K300x	275	350	
60V	60V		○	TFMOV20K391x	○	TFMOV34S391x	TFMOV34S391Lx	○	TFMOV40K391x	○	250	320	
			○	TFMOV20K361x	○	TFMOV34S361x	TFMOV34S361Lx	○	TFMOV40K361x	○	230	300	
48V	48V		○	TFMOV20K331x	○	TFMOV34S331x	TFMOV34S331Lx	○	TFMOV40K331x	○	210	275	
			○	TFMOV20K301x	○	TFMOV34S301x	TFMOV34S301Lx	○	TFMOV40K301x	○	190	250	
36V	36V		○	TFMOV20K271x	○	TFMOV34S271x	TFMOV34S271Lx	○	TFMOV40K271x	○	175	225	
			○	TFMOV20K241x	TFMOV20K150x	TFMOV34S241x	TFMOV34S241Lx	○	TFMOV40K241x	TFMOV40K150x	150	200	
24V	24V		○	TFMOV20K221x	○	TFMOV34S221x	TFMOV34S221Lx	○	TFMOV40K221x	○	140	180	
			○	TFMOV20K201x	○	TFMOV34S201x	TFMOV34S201Lx	○	TFMOV40K201x	○	130	170	
12V	12V		○	○	○	TFMOV34S181x	TFMOV34S181Lx	○	TFMOV40K181x	○	115	150	
			○	○	○	TFMOV34S151x	TFMOV34S151Lx	○	○	○	95	125	
AC	DC			TFMOV34S121Lx	○	○	○	○	○	○	75	100	
				TFMOV34S101Lx	○	○	○	TFMOV40K121x	○	○	60	85	
AC	DC			TFMOV34S820Lx	○	○	○	TFMOV40K101x	○	○	50	65	
				○	○	○	○	TFMOV40K820x	○	○	40	56	
AC	DC			○	○	○	○	○	○	○	35	45	
				○	○	○	○	○	○	○	30	38	
AC	DC			○	○	○	○	○	○	○	25	31	
				○	○	○	○	○	○	○	20	26	
AC	DC			○	○	○	○	○	○	○	17	22	
				○	○	○	○	○	○	○	17	22	

$I_{max} = 2.5 I_n$

标称放电电流 Nominal Discharge Current  $I_n$  (kA)

热保护型压敏电阻特性与型号概览  
Thermal Fuse & MOV (TFMOV) Feature & Model List Overview

额定电压 $U_n$ (V)		标称放电电流 Nominal Discharge Current $I_n$ (kA)						最大连续工作电压 Maximum Continuous Operating Voltage $U_n$ (V)		页码 Page
AC	DC	2.5 x 2	5 x 2	7.5 x 2	2.5 x 3	5 x 3	7.5 x 3	AC	DC	
690V	600V	○	○	○	○	○	○	750	1000	
		○	○	○	○	○	○	680	895	
480V		○	○	○	○	○	○	625	825	
	400V	○	○	○	○	○	○	550	745	
347V		○	○	○	○	○	○	510	670	
	254	○	○	○	○	○	○	460	615	
	277V	○	○	○	○	○	○	420	560	
220		○	○	TFMOV21R2P511	○	○	○	385	505	
	230V	○	○	TFMOV21R2P471	○	○	○	350	460	
	300V	○	○	TFMOV21R2P431	○	○	○	320	415	
	120	○	○	TFMOV21R2P391	○	○	○	300	385	
	130V	○	○	TFMOV21R2P361	○	○	○	275	350	
		○	○	TFMOV21R2P331	○	○	○	250	320	
		○	○	TFMOV21R2P301	○	○	○	230	300	
		○	○	TFMOV21R2P271	○	○	○	210	275	
		○	○	TFMOV21R2P241	○	○	○	190	250	
110V	110V	○	○	TFMOV21R2P221	○	○	○	175	225	
		○	○	TFMOV21R2P201	○	○	○	150	200	
		○	TFMOV21R2P181	○	○	○	○	140	180	
	60V	○	TFMOV21R2P151	○	○	TFMOV21R3P181	○	115	150	
48V	60V	○	TFMOV21R2P121	○	○	TFMOV21R3P151	○	95	125	
	48V	○	TFMOV21R2P101	○	○	TFMOV21R3P121	○	75	100	
	36V	○	TFMOV21R2P820	○	○	TFMOV21R3P101	○	60	85	
		TFMOV21R2P680	○	○	○	TFMOV21R3P820	○	50	65	
24V	24V	TFMOV21R2P560	○	○	TFMOV21R3P680	○	○	40	56	
		TFMOV21R2P470	○	○	TFMOV21R3P560	○	○	35	45	
		○	○	○	TFMOV21R3P470	○	○	30	38	
12V	12V	○	○	○	○	○	○	25	31	
		○	○	○	○	○	○	20	26	
		○	○	○	○	○	○	17	22	

# 热保护型压敏电阻 TFMOV

Thermal Fuse & MOV

## 产品描述 Description

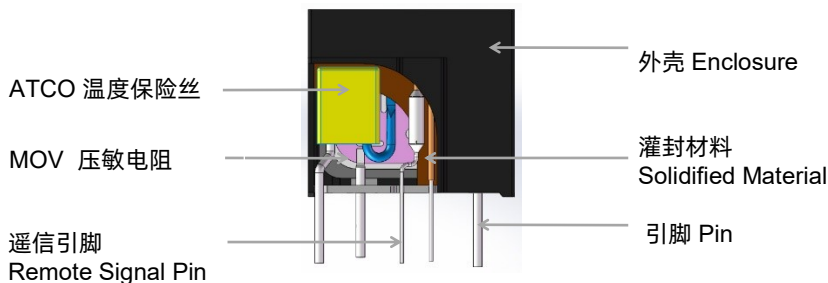
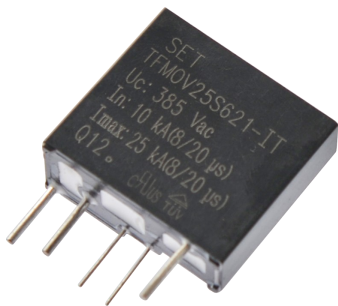

**TFMOV(ATCO)**  
热保护型压敏电阻（熔断合金型）

热保护型压敏电阻（TFMOV）是压敏电阻与热保护脱离部件的组合。压敏电阻存在老化特性，热保护型压敏电阻能够在压敏电阻（MOV）劣化或失效时，通过热保护部件的动作将压敏电阻从主回路中脱离。常用于光伏逆变器，通信设备，机房电源等对可靠性和耐候性要求高的场所。

TFMOV is a combination of varistors (MOV) and thermal protection component. Since varistor has the characteristics of aging or degrading; TFMOV can separate the varistor from the main circuitry by opening the thermal protection component when the varistor (MOV) degrades or fails. It is often used in which requires high reliability and weather withstanding, such as photovoltaic inverters, communication equipment, and power supplies in data centers, etc.

## 电气原理图 Schematics

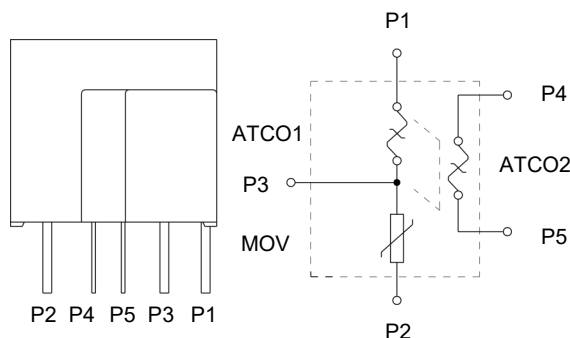

**TFMOV(ATCO)**  
热保护型压敏电阻（熔断合金型）

# 热保护型压敏电阻 TFMOV

Thermal Fuse & MOV

## 压敏电阻工作原理 MOV Operation Principle

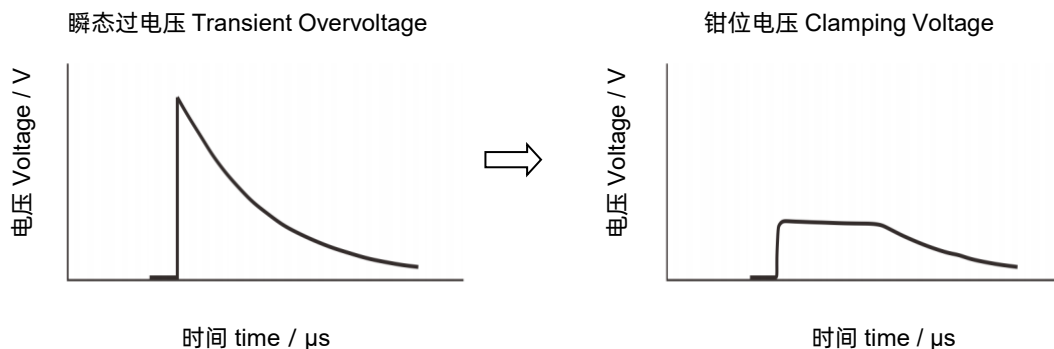

## 压敏电阻热保护 MOV Thermal Protection

图a为电源常用的电涌保护电路，采用MOV来抑制电涌电压，保护后级电路。由于压敏电阻在劣化或失效时，存在燃烧的风险。在图b高可靠性电涌保护电路中，为了提高电路安全性，采用热保护型压敏电阻TFMOV作为浪涌电压保护元件。热保护型压敏电阻（TFMOV）是压敏电阻与热保护脱离部件的组合。在MOV 温度异常超限时，温度保险丝会先断开，从而使MOV 的失效模式呈现开路失效。

Figure a is a surge protection circuit commonly used in power supplies. MOV is used to suppress the surge voltage and protect the subsequent circuit. There is a risk of burning when the varistor degrades or fails. In the high-reliability surge protection circuit of Figure b, in order to improve the safety of the circuit, a thermal protection varistor TFMOV is used as the surge voltage protection element. TFMOV is a combination of varistors (MOV) and thermal protection component. When the temperature of the MOV is abnormally exceeded, the thermal fuse will be opened first, so that the failure mode of the MOV appears to be open-circuit failure.

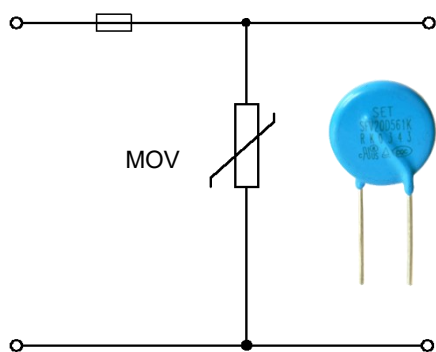

图a 电涌保护典型电路

Figure a Typical surge protection circuit

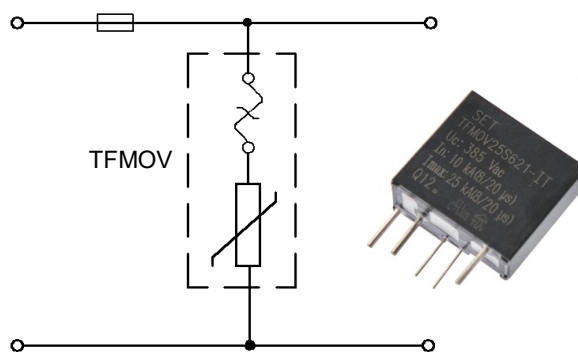

图b 电涌保护高可靠性电路

Figure b: High reliability surge protection circuit

# 热保护型压敏电阻 TFMOV

Thermal Fuse & MOV

## 优势 Benefits

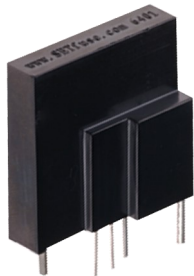

### 安全 Safety

### 安全隐患 Hidden Danger

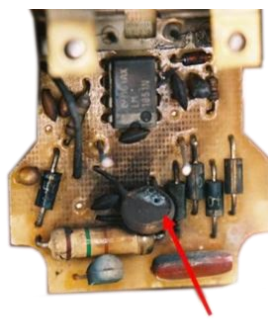
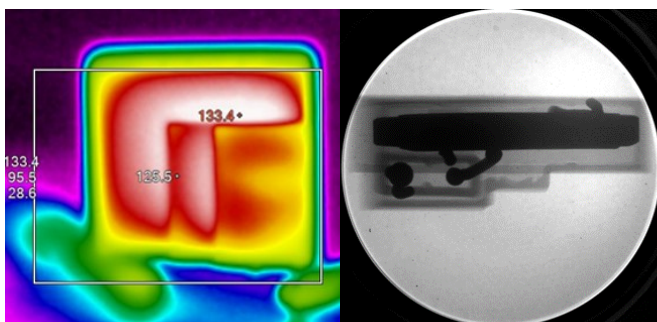

压敏电阻穿孔  
Hole in Varistor

### 模拟TFMOV劣化失效 TFMOV Failure Simulation

### 模拟MOV劣化失效 MOV Failure Simulation

TFMOV利用温度保险丝受热熔断的特性，在压敏电阻电性能劣化的过程中，当漏电流才达到数十毫安时，温度保险丝断开，形成如上图所示的开路失效，是可接受的安全失效。

During the electrical performance degrading of varistor, the inbuilt ATCO will open the circuit when the leakage current of varistor increases to tens of micro Amperes. As shown in the figure above, this is a safe open circuit failure.

众所周知，压敏电阻在使用过程中会出现电性能劣化，绝大多数会呈现压敏电压下降、漏电流增加，因热量累积导致温度剧升，使得压敏电阻出现如上图的热击穿而短路失效，存在安全隐患！

The electrical performance of varistor degrades with operating, mostly the varistor voltage drops, and leakage current increases. The heat accumulation can cause the temperature increase sharply and varistor results in thermal breakdown to short circuit status. It's very dangerous.



## 热保护型压敏电阻 TFMOV

Thermal Fuse &amp; MOV

## 型号说明 Part Numbering System

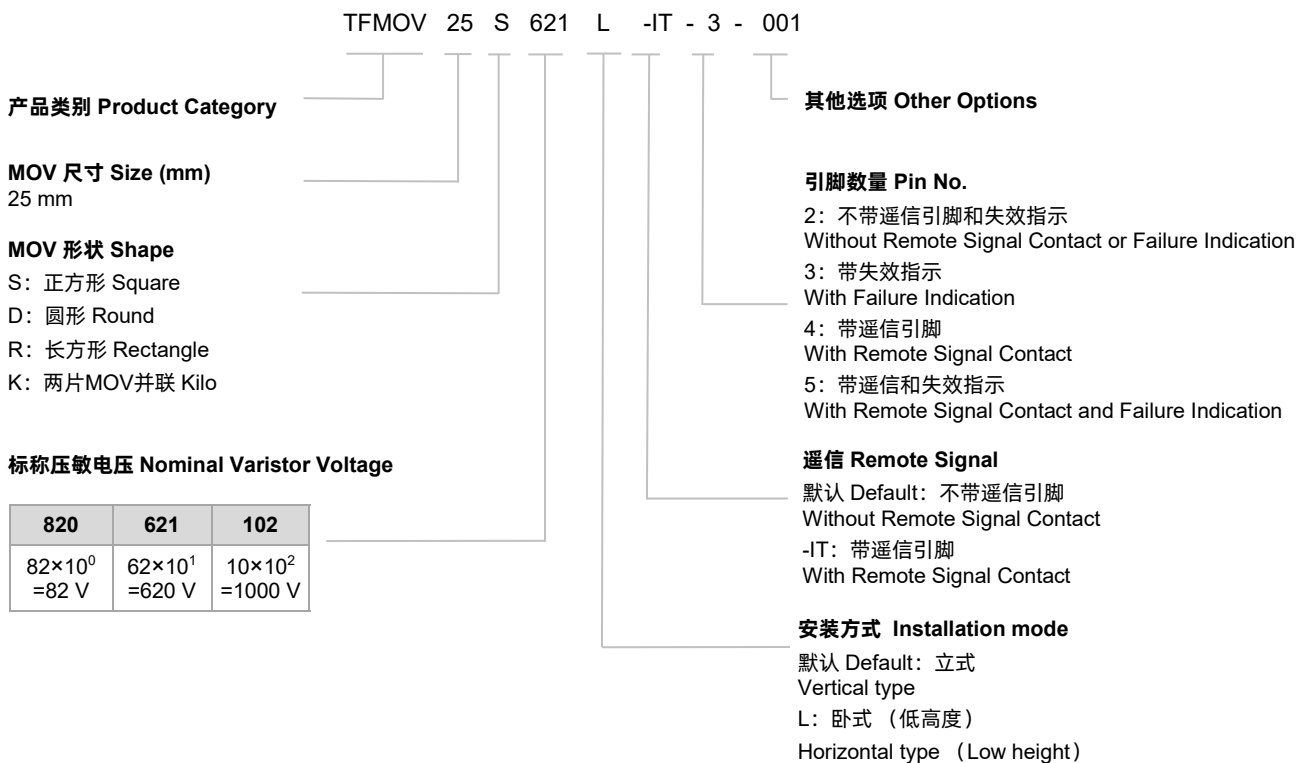

备注 Note:

引脚数量和其他选项仅作为内部唯一规格的认识编码，不作为产品型号一部分。

Pin number and other options are used only as identification codes for internal unique specifications and are not part of the product model

# 热保护型压敏电阻 TFMOV

Thermal Fuse & MOV

## 标称放电电流 Nominal Discharge Current

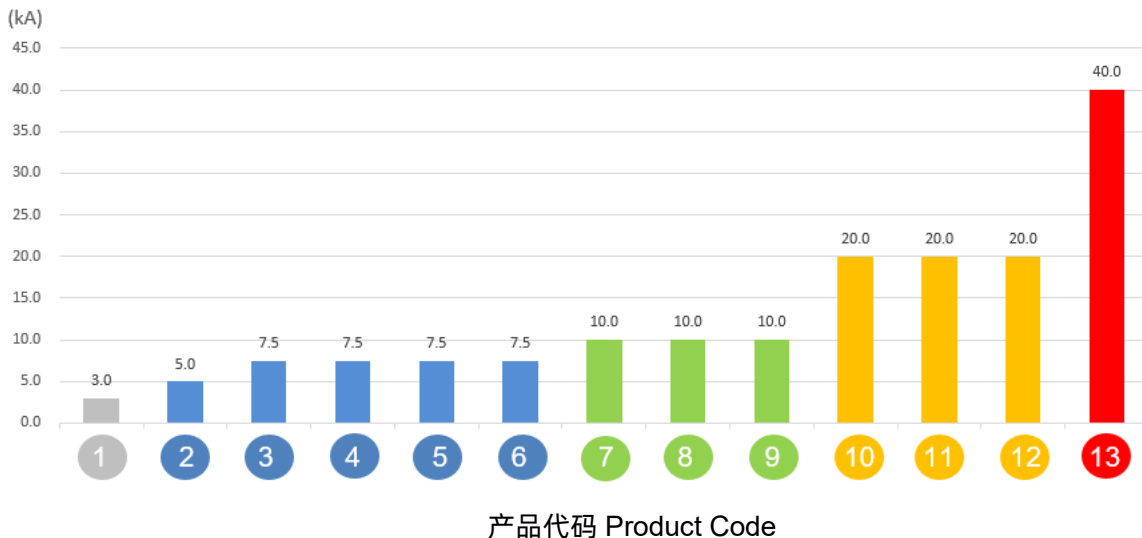

- 1 TFMOV10S Series
- 2 TFMOV15S Series      3 TFMOV20S Series      4 TFMOV20SxxxL Series
- 5 TFMOV21R2P Series      6 TFMOV21R3P Series
- 7 TFMOV25S Series      8 TFMOV25SxxxL Series      9 TFMOV25D Series
- 10 TFMOV34S Series      11 TFMOV34SxxxL Series      12 TFMOV20K Series
- 13 TFMOV40K Series

## 应用示例 Application Options

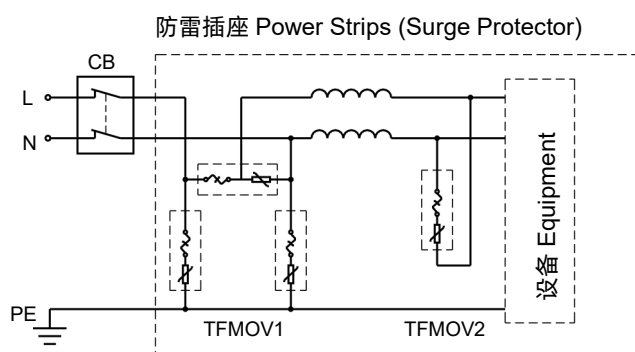
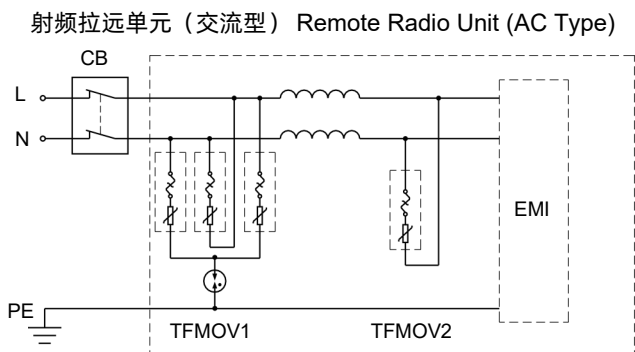

# 热保护型压敏电阻 TFMOV

Thermal Fuse & MOV

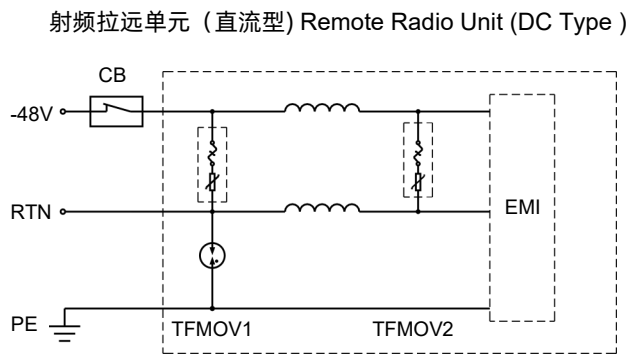
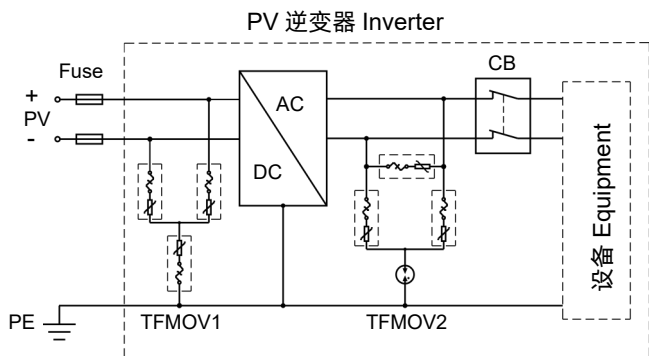

## 设计 Design

当单一器件的通流容量无法达到设计要求时，通常采用并联的方式满足需求，由于其非线性的电流-电压特性，并联使用过程中应注意以下事项：

1. 需要选用同一厂家，同一型号的压敏电阻进行并联；
2. 需要控制压敏电阻的压敏电压；通常，同一组中间的压敏电压偏差小于1%（最大与最小之间），同时满足下一条；
3. 按平均分配计算的通流容量并留有10%以上的裕量；
4. 设计时需要考虑回路中的浪涌电流均匀分布，如图2。

When a single TFMOV surge capacity can't meet the requirement of customers, paralleling more TFMOVs is recommended.

Due to its nonlinear current-voltage characteristics, please pay attention to below tips:

1. Use the TFMOV from the same manufacturer with same model to parallel.
2. Control the varistor voltage; Typically, the varistor voltage deviation should be less than 1% in the same group (between the Max and Min), and meet the next tip at the same time.
3. Calculate the average surge capacity for each TFMOV and keep a margin at least 10%.
4. Design the layout like Figure.2. to make sure the surge capacity is divided averagely.

错误的设计 The Design not Recommended



图 Figure.1

推荐的设计 The Design Recommended





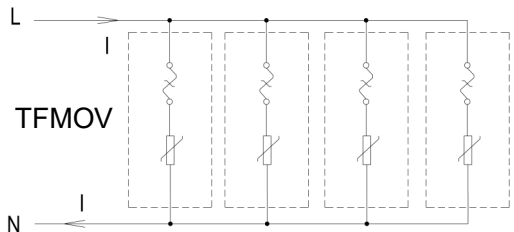

图 Figure.2

## 热保护型压敏电阻 TFMOV

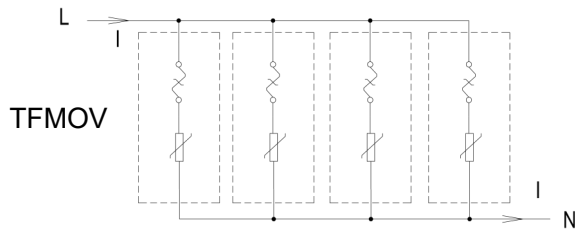
Thermal Fuse &amp; MOV

## 认证信息 Agency Information

认证信息 Agency Information		标准 Standards	档案号 File NO.	类别 Category
	UL	UL 1449 4th Edition	E322662	VZCA2
	CUL	CSA C22.2 NO.8, CSA ECN 516	E322662	VZCA8
	TUV	EN 61643-11	详见具体型号 See the different models for details	
	CQC	GB 4943.1-2011, GB 8898-2011; GB/T 10193-1997, GB/T 10194-1997	详见具体型号 See the different models for details	

## 专利 Patents

名称 Name	区域 Region	专利类别 Category	专利号 Patent NO.
设有合金型温度保险丝的压敏电阻 Varistor with In-built Alloy-Type Thermal Fuse	中国 China	发明专利 Patent for Invention	ZL 200510044661.5
一种具有过流过压过温保护功能的电源插座模块 A Protection Pluggable Module with Over Current、Over Voltage、and Over Temperature Protection Function	中国 China	实用新型 Utility Model	ZL 201020244488.X
一种带有双重保护功能的压敏电阻器 A Varistor with Double Protection Function	中国 China	实用新型 Utility Model	ZL 201020255481.8
防雷插座用的防雷模块 Surge Protection Module Applicable for Power Strip	中国 China	实用新型 Utility Model	ZL 201120107173.5
一种防雷插座用的防雷模块 A Surge Protection Module Applicable for Power Strip	中国 China	发明专利 Patent for Invention	ZL 201110092261.7
新型的热保护压敏电阻及浪涌保护器 A New Type of Varistor and Surge Protective Device with Thermal Protection	中国 China	实用新型 Utility Model	ZL 201420306127.1
一种浪涌保护器 A Surge Protective Device	中国 China	实用新型 Utility Model	ZL 201420415059.2
一种热保护压敏电阻及其组合元件 A Varistor and Thermal Protection Component Combination	中国 China	实用新型 Utility Model	ZL 201520376567.9
具合金型温度保险丝的压敏电阻 合金型温度ヒューズ付のバリスタ	日本 Japan	实用新型 Utility Model	3142835
设有合金型温度保险丝的压敏电阻 Varistor with an Alloy-Type Temperature Fuse	澳大利亚 Australia	实用新型 Utility Model	2007100456
具合金型温度保險絲的壓敏電阻 Varistor with an Alloy-Type Temperature Fuse	台湾 Taiwan	实用新型 Utility Model	M 300855
设有合金型温度保险丝的压敏电阻 Varistor with an Alloy-type Temperature Fuse	加拿大 Canada	发明专利 Patent for Invention	2588819
设有合金型温度保险丝的压敏电阻 Metal Oxide Varistor with Built-in Alloy-Type Temperature Fuse	美国 USA	发明专利 Patent for Invention	US 8780521
设有合金型温度保险丝的压敏电阻-带外壳 Varistor with In-built Alloy Type Thermal Fuse (with Housing)	美国 USA	发明专利 Patent for Invention	US 9355763

## 热保护型压敏电阻 TFMOV

Thermal Fuse &amp; MOV

## 术语 Glossary

项目 Item	定义 Description
$V_N$	<b>标称压敏电压 Nominal Varistor Voltage</b> 在特定持续时间的脉冲电流下测得压敏电阻两端的电压。 Voltage, at specified d.c. current used as a reference point in the component characteristic.
8/20 $\mu$ s	<b>8/20 冲击电流 Current Impulse</b> 视在波前时间为8 $\mu$ s, 半峰值时间为20 $\mu$ s的冲击电流。 Current impulse with a nominal virtual front time of 8 $\mu$ s and a nominal time to half-value of 20 $\mu$ s. — (IEC 61643-11)
1.2/50 $\mu$ s	<b>1.2/50 冲击电压 Voltage Impulse</b> 视在波前时间为1.2 $\mu$ s, 半峰值时间为50 $\mu$ s的冲击电压。 Voltage impulse with a nominal virtual front time of 1.2 $\mu$ s and a nominal time to half-value of 50 $\mu$ s. — (IEC 61643-11)
$U_c$	<b>最大持续工作电压 Maximum Continuous Operating Voltage</b> 可连续地施加在SPD上的最大交流电压有效值。 Maximum r.m.s. voltage, which may be continuously applied to the SPD's mode of protection. — (IEC 61643-11)
$I_n$	<b>标称放电电流 Nominal Discharge Current</b> 流过SPD具有 8/20 波形电流的峰值 Crest value of the current through the SPD having a current waveshape of 8/20. — (IEC 61643-11)
$I_{imp}$	<b>I 类试验的冲击电流 Impulse Discharge Current for Class I Test</b> $I_{imp}$ 由三个参数来定义: 电流峰值 $I_{peak}$ 、电荷量 Q 和比能量 W/R Crest value of a discharge current through the SPD with specified charge transfer Q and specified energy W/R in the specified time. — (IEC 61643-11)
$I_{max}$	<b>最大放电电流 Max. Discharge Current</b> 具有 8/20 波形和制造厂声称幅值的流过SPD电流的峰值。 $I_{max}$ 等于或大于 $I_n$ 。 Crest value of a current through the SPD having an 8/20 waveshape and magnitude according to the manufacturers specification. $I_{max}$ is equal to or greater than $I_n$ . — (IEC 61643-11)
$V_c$	<b>钳位电压 Clamping Voltage</b> 在标准大气压环境下, 压敏电阻中流过 8/20 等级电流脉冲时, 压敏电阻两端呈现的电压峰值。 Peak voltage developed across the varistor terminations under standard atmospheric conditions, when passing an 8/20 class current pulse.
$C_v$	<b>电容量 Capacitance</b> 特定频率和电压下压敏电阻两端测得的电容量。 Capacitance across the MOV measured at a specified frequency and voltage.

# 热保护型压敏电阻 TFMOV

Thermal Fuse & MOV

## 术语 Glossary

项目 Item	定义 Description
<b>Modes of protection</b>	<p><b>保护模式 Modes of protection</b></p> <p>在端子间包含保护元件的电流路径，例如相对相、相对地、相对中线、中线对地。 An intended current path, between terminals that contains protective components, e.g. line-to-line, line-to-earth, line-to-neutral, neutral-to-earth.</p> <p style="text-align: right;">— (IEC 61643-11)</p>
<b>TCO</b>	<p><b>热熔断体 Thermal-Link</b></p> <p>装有温感元件的不可复位器件，当它暴露在高于设定温度达到一定时间就会将电路断开。 A non-resettable device incorporating a THERMAL ELEMENT which will open a circuit once only when exposed for a sufficient length of time to a temperature in excess of that for which it has been designed.</p>
<b>ATCO</b>	<p><b>合金热熔断体 Alloy Thermal-Link</b></p> <p>温感元件由合金材料制作的热熔断体。 Alloy Type Thermal-Link, Alloy is the thermal element.</p>

TFMOV

TFMOV

# 热保护型压敏电阻 TFMOV

Thermal Fuse & MOV



## 注意 ATTENTION

### 使用方法 Usage

1. 交流频率在47 Hz和63 Hz之间。  
Frequency range is from 47 Hz to 63 Hz a.c.
2. 持续施加在热保护型压敏电阻上的电压不应超过其最大连续工作电压 $U_c$ 。  
The voltage applied continuously to the TFMOV can not exceed its maximum continuous operating voltage  $U_c$ .
3. 气压在80 kPa 到106 kPa, 对应海拔为+2000 m至- 500 m。  
When atmosphere press is from 80 kPa to 106 kPa, the related altitude shall be from +2000 m to -500 m.
4. 通电情况下请勿直接触碰本体或引脚, 防止触电。  
Do not touch the product body or pins directly when power is on, to avoid electric shock.
5. 请不要用酮类、酯类、苯类、卤代烃等极性溶剂清洗本产品, 以免破坏产品的封装层。  
Do not clean the TFMOV with strong polar solvent such as ketone, esters, benzene, halogenated hydrocarbon, to avoid damaging the encapsulating layer.
6. 应用本产品的设备必须有可靠的接地线与大地相连。  
It should have a reliable grounding when using these products.

### 更换 Replacement

基于安全原因, 热保护型压敏电阻是不可修复的产品, 替换时应使用同类别同型号的产品。  
TFMOV is a non-repairable product. For safety sake, please use equivalent TFMOV for replacement.

### 存贮 Storage

热保护型压敏电阻的存贮应避免高温、高湿、日光直射和腐蚀性气体的场合, 避免影响引脚可焊性, 产品购入后请于1年内使用完。  
Do not store TFMOV at high temperature, high humidity or corrosive gas environment. To avoid reducing the solderability of the pins, please use them up within 1 year after receiving the goods.

### 安装位置 Installation Position

勿将热保护型压敏电阻安装在可能经常出现剧烈振动的地方。  
Do not install the TFMOV on a place that may often suffer severe continuous vibration.

# 热保护型压敏电阻 TFMOV

Thermal Fuse & MOV

## 机械应力 Mechanical Stress

装配时应避免出现如敲击等作业方式，避免造成产品出现机械损伤。  
Do not take violent action such as knocking when assembling to avoid mechanical damage.

## 波峰焊参数 (参考) Wave Soldering Parameters (For Reference Only)

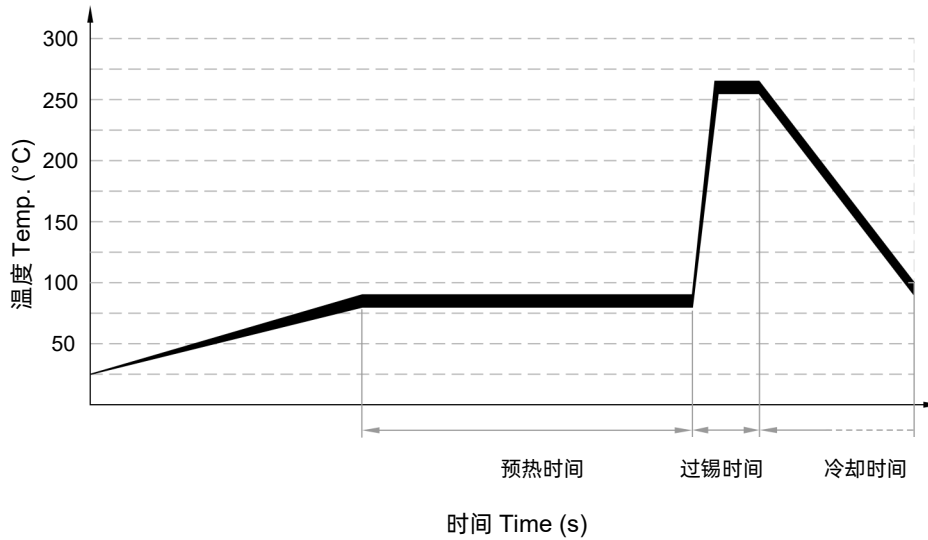

项目 Items	温度 Temp. (°C)	时间 Time (s)
预热 Preheating	80 to 90	60 to 150
过锡 Dwelling	250 to 260	2 to 4

## 推荐的手工焊参数 Recommended Hand-Soldering Parameters

项目 Item	条件 Condition
烙铁头温度 Iron Temperature	350 °C (Max.)
焊接时间 Soldering Time	4 seconds (Max.)
焊接点距产品底部的距离 Distance between Soldering Point and the Bottom of Product	2 mm (Min.)



# 热保护型压敏电阻 TFMOV

Thermal Fuse & MOV

TFMOV25S 系列 Series

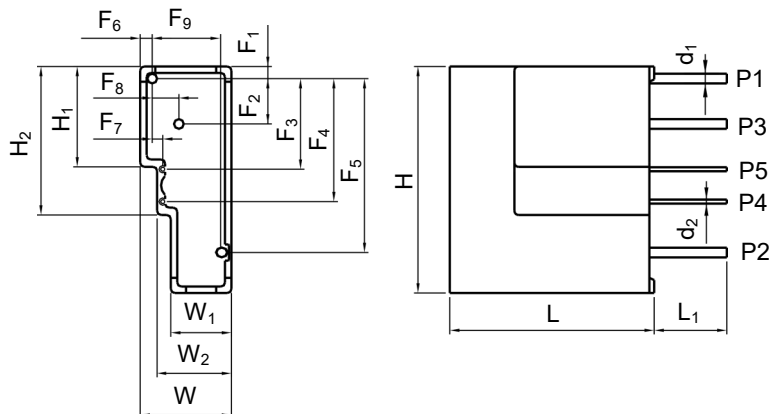
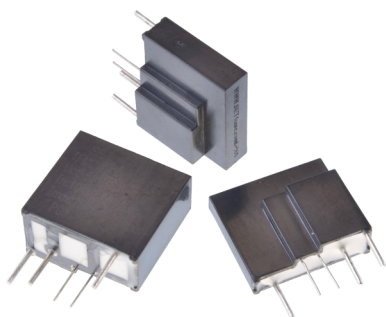

备注 Note:

引脚 P3 / P4 / P5 可选 Pin P3 / P4 / P5 is Optional

单位 Unit: mm

标称压敏电压 Nominal Varistor Voltage	L (±1.0)	L <sub>1</sub> (±1.0)	W (±1.0)	W <sub>1</sub> (±1.0)	W <sub>2</sub> (±1.0)	H (±1.0)	H <sub>1</sub> (±0.5)	H <sub>2</sub> (±0.5)	F <sub>1</sub> (±0.5)	F <sub>2</sub> (±0.5)
270 - 121	25.3	9.0	9.4	5.6	7.5	28.0	12.4	18.4	1.5	5.6
151 - 271	25.3	9.0	9.8	6.0	7.7	28.0	12.4	18.4	1.5	5.6
301 - 471	25.3	9.0	11.3	7.5	9.2	28.0	12.4	18.4	1.5	5.6
511 - 681	25.3	9.0	12.3	8.5	10.2	28.0	12.4	18.4	1.5	5.6
751 - 821	25.3	9.0	13.3	9.5	11.2	28.0	12.4	18.4	1.5	5.6
911 - 122	25.3	9.0	15.8	12.0	13.7	28.0	12.4	18.4	1.5	5.6
标称压敏电压 Nominal Varistor Voltage	F <sub>3</sub> (±0.5)	F <sub>4</sub> (±0.5)	F <sub>5</sub> (±0.5)	F <sub>6</sub> (±0.5)	F <sub>7</sub> (±0.5)	F <sub>8</sub> (±0.5)	F <sub>9</sub> (±0.5)	d <sub>1</sub> (-0.05,+0.15)	d <sub>2</sub> (±0.05)	
270 - 121	11.2	15.2	21.5	1.5	1.3	3.3	6.9	1.20	0.50	
151 - 271	11.2	15.2	21.5	1.5	1.3	3.3	7.3	1.20	0.50	
301 - 471	11.2	15.2	21.5	1.5	1.3	3.3	8.8	1.20	0.50	
511 - 681	11.2	15.2	21.5	1.5	1.3	3.3	9.8	1.20	0.50	
751 - 821	11.2	15.2	21.5	1.5	1.3	3.3	10.8	1.20	0.50	
911 - 122	11.2	15.2	21.5	1.5	1.3	3.3	13.3	1.20	0.50	

## 安规认证 Agency Approvals

机构 Agency	标准 Standards	档案号 No.
US	UL1449	E322662
TÜV Rheinland	EN 61643-11	J 50210179
	GB 4943.1-2011 GB 8898-2011	CQC18001188616
环境 Environment	RoHS & REACH	符合 Compliant

## 电气原理图 Schematics

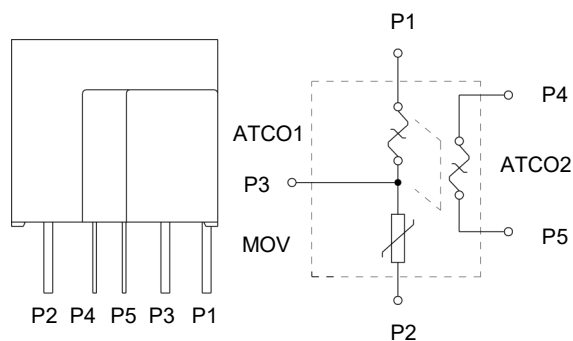

# 热保护型压敏电阻 TFMOV

Thermal Fuse & MOV

TFMOV25S 系列 Series

## 技术参数 Specifications

型号 Model	最大连续工作电压 Max. Continuous Operating Voltage		压敏电压 Varistor Voltage @1 mA DC		钳位电压 Clamping Voltage (Max.)		标称放电电流 Nominal Discharge Current (8/20 μs)	最大放电电流 Max. Discharge Current (8/20 μs)	限压比 Voltage Clamping Ratio <sup>a</sup>		最大能量 (焦耳) Max. Energy (Joule)	静态电容 (参考) Typical Capacitance (Reference)	温度保险丝 Thermal Fuse
	U <sub>c</sub>		Min.	Max.	V <sub>C</sub>	I <sub>P</sub>	I <sub>n</sub>	I <sub>max</sub>	R <sub>cl</sub>	I <sub>n</sub>	10/1000 μs	@1 kHz	UL 60691 E214712
	(VAC)	(VDC)	(V)		(V)	(A)	(kA)			(kA)	(J)	(pF)	
TFMOV25S270x	17	22	24	31	53	35	3	6	4.6	3	33	30000	VT 系列 Series U <sub>i</sub> :690 VAC I <sub>t</sub> :15 A / 16 A
TFMOV25S330x	20	26	30	36	65	35	4	8	4.6	4	42	24500	
TFMOV25S390x	25	31	35	43	77	35	4	8	4.6	4	49	21000	
TFMOV25S470x	30	38	42	52	93	35	4	8	4.3	4	60	17250	
TFMOV25S560x	35	45	50	62	110	35	5	10	3.8	5	72	14500	
TFMOV25S680x	40	56	61	75	135	35	5	10	3.8	5	85	9500	
TFMOV25S820x	50	65	74	90	135	175	8	16	3.2	8	98	8800	
TFMOV25S101x	60	85	90	110	165	175	8	16	3.2	8	122	7200	
TFMOV25S121x	75	100	108	132	200	175	8	16	3.2	8	146	6000	
TFMOV25S151x	95	125	135	165	250	175	8	16	3.2	8	185	4400	
TFMOV25S181x	115	150	162	198	300	175	8	16	2.3	8	218	3650	
TFMOV25S201x	130	170	185	225	340	175	10	25	2.3	10	252	3300	
TFMOV25S221x	140	180	198	242	360	175	10	25	2.3	10	280	3000	
TFMOV25S241x	150	200	216	264	395	175	10	25	2.3	10	302	2800	
TFMOV25S271x	175	225	243	297	455	175	10	25	2.3	10	340	2450	
TFMOV25S301x	190	250	270	330	500	175	10	25	2.3	10	375	2200	
TFMOV25S331x	210	275	297	363	550	175	10	25	2.3	10	410	2050	
TFMOV25S361x	230	300	324	396	595	175	10	25	2.3	10	465	1850	
TFMOV25S391x	250	320	351	429	650	175	10	25	2.3	10	520	1700	
TFMOV25S431x	275	350	387	473	710	175	10	25	2.3	10	575	1600	
TFMOV25S471x	300	385	423	517	775	175	10	25	2.3	10	630	1450	
TFMOV25S511x	320	415	459	561	845	175	10	25	2.3	10	665	1300	
TFMOV25S561x	350	460	504	616	925	175	10	25	2.3	10	720	1200	
TFMOV25S621x	385	505	558	682	1025	175	10	25	2.3	10	790	1100	
TFMOV25S681x	420	560	612	748	1120	175	10	25	2.3	10	790	1000	
TFMOV25S751x	460	615	675	825	1240	175	10	25	2.3	10	825	900	
TFMOV25S821x	510	670	738	902	1355	175	10	25	2.3	10	840	800	
TFMOV25S911x	550	745	819	1001	1500	175	10	25	2.3	10	900	700	
TFMOV25S102x	625	825	900	1100	1650	175	10	25	2.3	10	950	660	
TFMOV25S112x	680	895	990	1210	1815	175	10	25	2.3	10	1040	615	
TFMOV25S122x	750	1000	1080	1320	1980	175	10	25	2.3	10	1170	555	

# 热保护型压敏电阻 TFMOV

Thermal Fuse & MOV

TFMOV25S 系列 Series

备注 Note:

a:  $R_{cl} = \frac{V_C}{I_n}$ ,  $U_p \geq V_C$ ,  $V_C$ : 钳位电压 (@  $I_n$ ),  $V_N$ : 压敏电压,  $U_p$ : 电压保护水平; 电压保护水平 ( $U_p$ ) 根据计算结果按 IEC 61643-11:2011 6.4 条款优选值选定; 电压保护水平优选值(kV): 0.08, 0.09, 0.10, 0.12, 0.15, 0.22, 0.33, 0.4, 0.5, 0.6, 0.7, 0.8, 0.9, 1.0, 1.2, 1.5, 1.8, 2.0, 2.5, 3.0, 4.0, 5.0, 6.0, 8.0, 10.

a:  $R_{cl} = \frac{V_C}{I_n}$ ,  $U_p \geq V_C$ ,  $V_C$ : Clamping Voltage (@  $I_n$ ),  $V_N$ : Varistor Voltage,  $U_p$ : Voltage Protection Level.

The Value of Voltage Protection Level ( $U_p$ ) is determined according to IEC 61643-11:2011 clause 6.4. Preferred values of voltage protection level (kV): 0.08, 0.09, 0.10, 0.12, 0.15, 0.22, 0.33, 0.4, 0.5, 0.6, 0.7, 0.8, 0.9, 1.0, 1.2, 1.5, 1.8, 2.0, 2.5, 3.0, 4.0, 5.0, 6.0, 8.0, 10.

## 性能曲线 Performance Curve

受限电流测试曲线 (UL 1449 4th 44.4章) Limited Current Test Curve (UL 1449 4th clause 44.4)

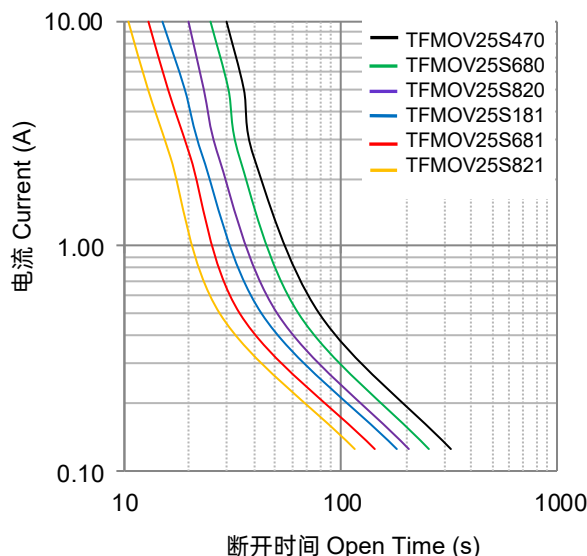

备注: 受限电流测试曲线仅供参考 Note: The limited current test curve is for reference only.

冲击电流降额曲线 Max. Peak Current Derating Curve

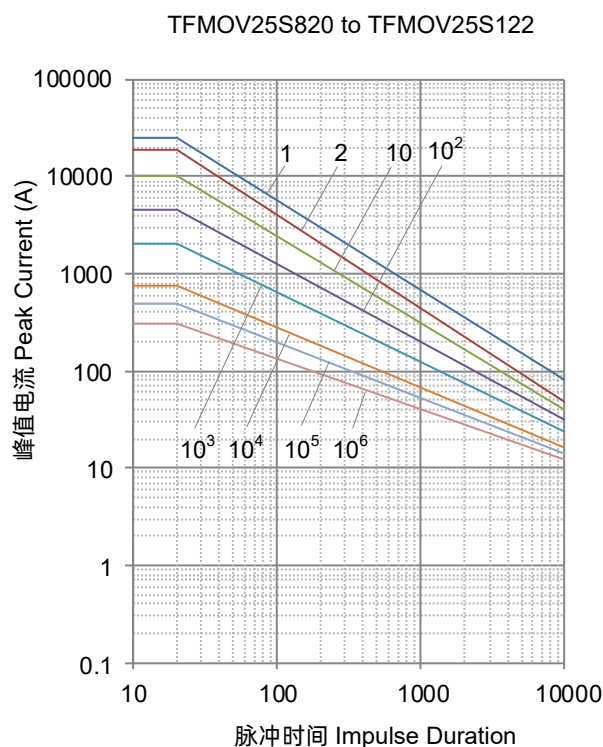
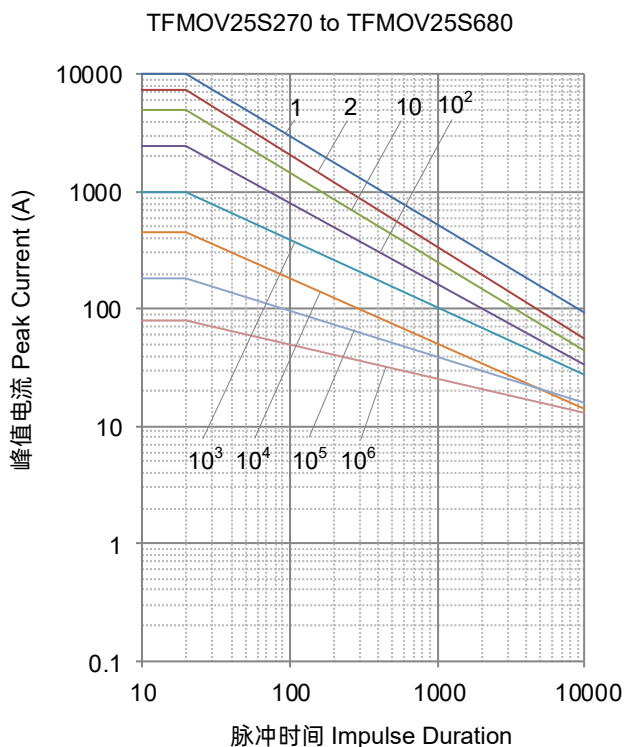

备注 Note: 1, 2, 10, 10<sup>2</sup>, 10<sup>3</sup>, 10<sup>4</sup>, 10<sup>5</sup>, 10<sup>6</sup> 代表重复次数 Stand for number of repetitions.

伏安特性曲线 Voltage-Current Characteristic Curves

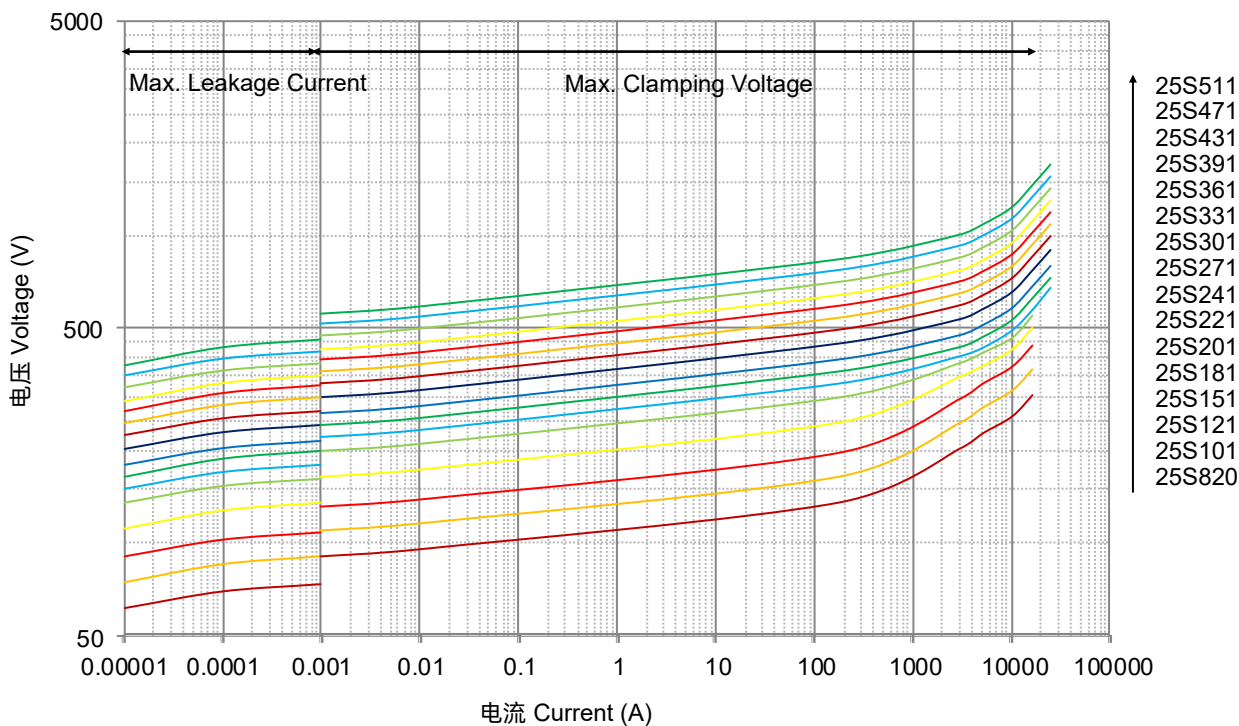
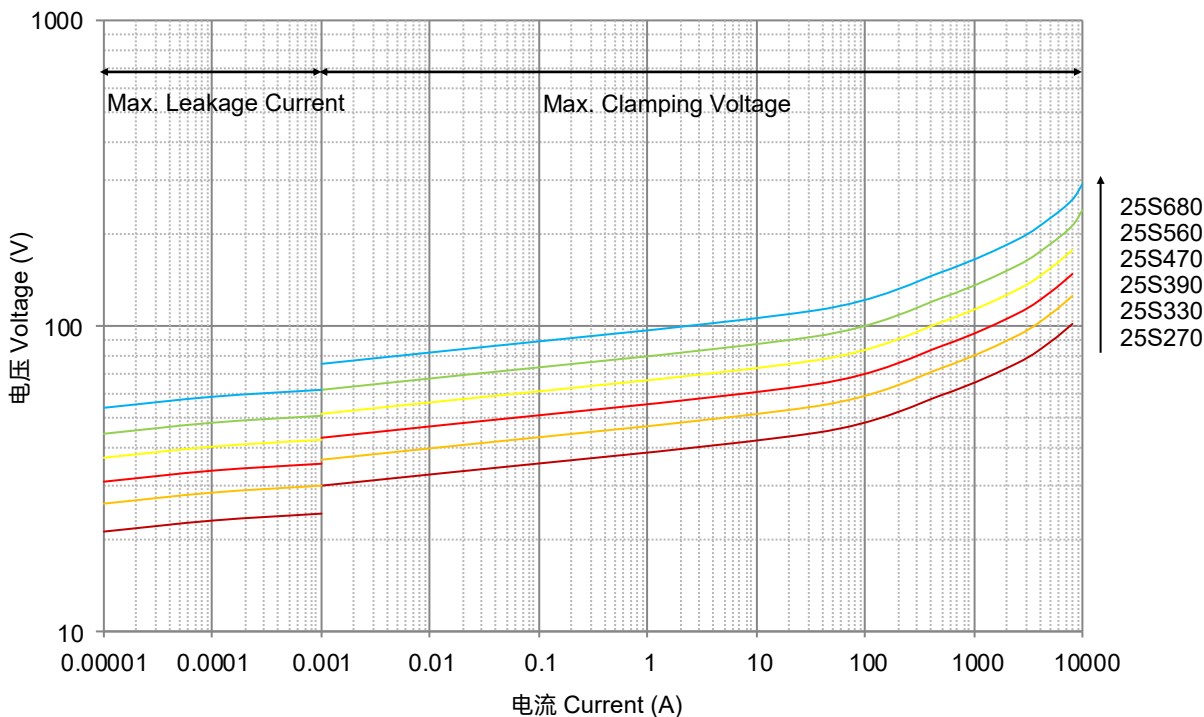

# 热保护型压敏电阻 TFMOV

Thermal Fuse & MOV

TFMOV25S 系列 Series

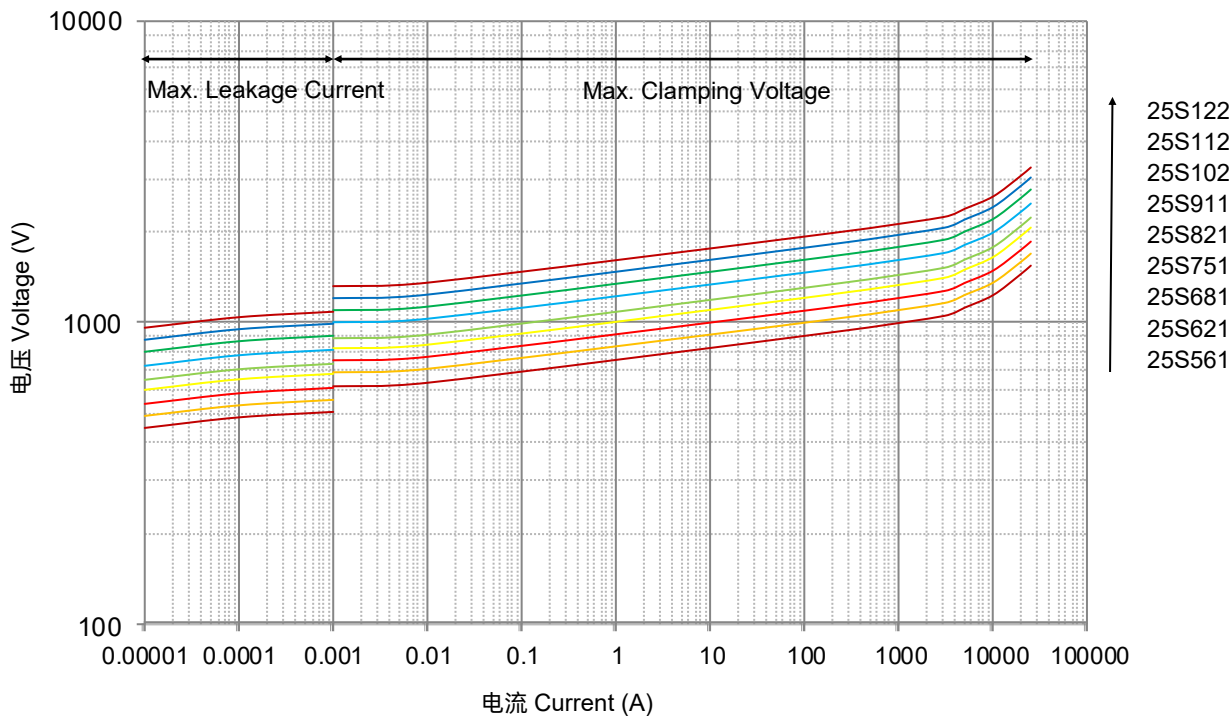

## 包装信息 Packaging Information

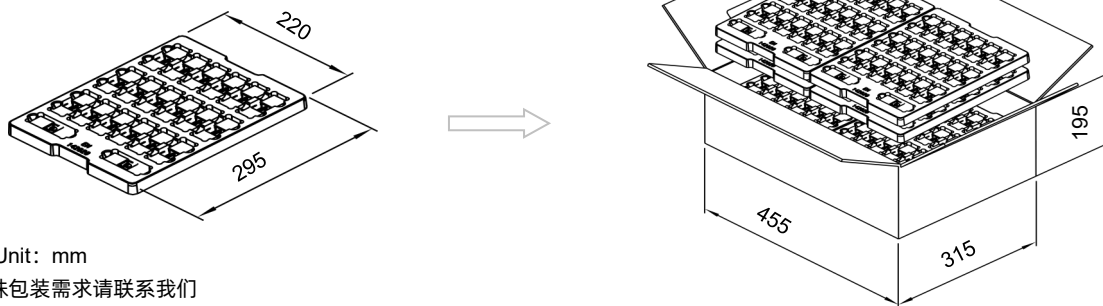

单位 Unit: mm

有特殊包装需求请联系我们

Please contact us if you have special packaging requirements.

项目 Item	标称压敏电压 Nominal Varistor Voltage	托 Tray	箱 Carton
尺寸 Dimensions (mm)	N/A	295 × 220	455 × 315 × 195
数量 Quantity (PCS)	270 - 271	40	800
	301 - 821	40	640
	911 - 122	40	480