



特性 Features

- 快速响应 Fast Response
- 性能稳定 Stable Performance Over Life
- 高通流 High Current Rating
- 低电容 Low Capacitance
- 高绝缘 High insulation Resistance
- 符合欧盟RoHS & REACH环保要求
RoHS & REACH Compliant

应用 Applications

- 宽带装置 Broadband Devices
- 有线电视和卫星设备 CATV and Satellite Equipment
- MDF配线架 MDF Module
- 基站和天线 Base Station And Antenna
- XDSL, Modem
- 电源与射频系统 Power Supply And RF Systems
- 消费类电子 Consumer Electronics
- 交流电源的N-PE保护
N-PE Mode Protection In AC Power

编码系统 Part Number System

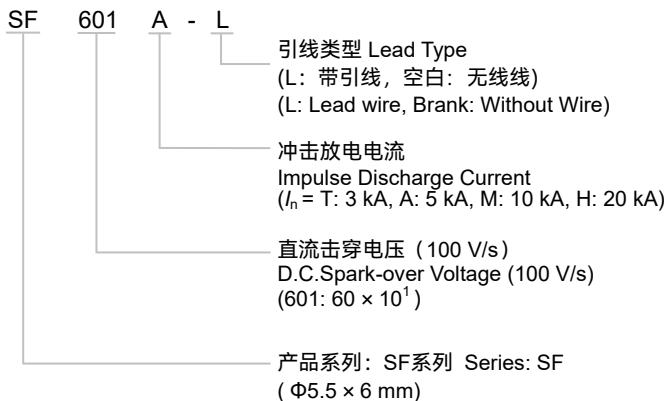

产品描述 Description

气体放电管是一种在金属电极和金属化陶瓷的空间里，充入一定比例的情性气体或与其它混合气体等放电介质，经过高温封接而成单间隙或多间隙的开关型防护器件。当被保护的电路或设备受到浪涌冲击时，放电管将从高阻抗状态变为低阻抗状态释放浪涌能量到地，降低电路残压，进而保护设备电路或人身免受瞬态过电压的危害。

A gas discharge tube is a single-gap or multi-gap switch type protective device in a space enclosed by metal electrodes and metallized ceramics, discharge media such as inert gas or gas mixture are filled at different atmospheric pressures to form single-gap or multi-gap switch-type protective devices. They have high insulation resistance plus low capacitance and leakage to ensure minimal effect on normal operation of equipment.

安规认证 Agency Approvals

认证机构 Agency	认证标准 Standards	文件号 File No.
	UL497B	E513446
	TUV	No.B107221003 Rev00

尺寸 Dimensions (mm)

带引线的轴向结构
Leaded "L" Type Straight "Axial" Devices

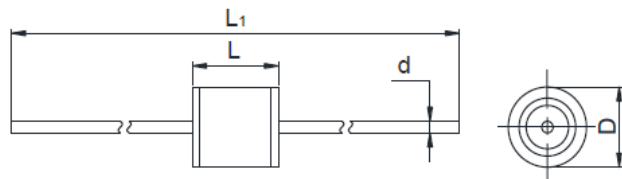

无引线结构 Core Devices

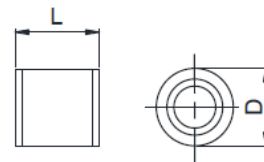

L ₁	L	D	d
62.0 ± 3.0	6.0 ± 0.5	Φ5.5 ± 0.5	0.8 ± 0.05

术语 Glossary

项目 Item	描述 Description
V_s	直流击穿电压 D.C Spark-over Voltage 气体放电管两端施加一个缓慢上升使其击穿的直流电压 The voltage at which the gas discharge tube sparks over with slowly increasing d.c. voltage . — (IEC 61643-311)
V	冲击击穿电压 Impulse Spark-over Voltage 从施加给定波形的冲击起直至开始有电流流通的这段时间内，气体放电管两端子上出现的最高电压。 The highest Voltage which appears across the terminals of a gas discharge tube in the period between the application of an impulse of given wave-shape and the time when current begins to flow. — (ITU-T K.12)
V_a	弧光电压 arc Voltage 在低阻抗或正常动作状态下,弧光电流流过气体放电管时的电压降。 Voltage drop across the GDT during arc current flow. — (IEC 61643-311)
V_{gl}	辉光电压 Glow Voltage 辉光电流流经期间,跨越 GDT 的电压降的峰值，它有时也被称为辉光模式电压。 He peak value of the voltage drop across the GDT when a glow-current is flowing. It is sometimes called the glow mode voltage. — (ITU-T K.12)
8/20 μs	8/20 冲击电流 8/20 Current Impulse 一个上升时间为8 μs ,半峰值时间为20 μs 的冲击电流波形。 Current impulse with a nominal virtual front time of 8 μs and a nominal time to half-value of 20 μs . — (IEC 61643-11)
1.2/50 μs	1.2/50 Voltage Impulse 一个上升时间为1.2 μs , 半峰值时间为50 μs 的冲击电压波形。 Voltage impulse with a nominal virtual front time of 1.2 μs and a nominal time to half-value of 50 μs . — (IEC 61643-11)
I	交流放电电流 Alternating Discharge Current 流经气体放电管的近似正弦交流电流的有效值。 The r.m.s. value of an approximately sinusoidal alternating current passing through the gas discharge tube. — (ITU-T K.12)
I_n	标称放电电流 Nominal Discharge Current 允许通过气体放电管波形为8/20 μs 冲击电流值。 Crest value of the current through the GDT having a current waveshape of 8/20 μs . — (IEC 61643-11)
I_{max}	最大放电电流 Maximum Discharge Current 允许通过气体放电管波形为8/20 μs 冲击电流最大值，该由制造厂商自行规定,一般 I_{max} 大于 I_n 。 Crest value of a current through the GDT having an 8/20 μs waveshape and magnitude according to the manufacturers specification. I_{max} is equal to or greater than I_n . — (IEC 61643-11)

GDT

GDT

技术参数 Specifications

型号 Model	直流击穿电压 D.C. Spark-over Voltage @100 V/s	电压范围 Tolerance of V_s	冲击击穿电压 Impulse Spark-over Voltage @1 kV/ μ s	弧光电压 Arc Voltage @1 A	冲击放电电流 Impulse Discharge Current @8/20 μ s	交流放电电流 Alternating Discharge Current @50Hz 1 s	绝缘电阻 Insulation Resistance		电容 Capacitance 0.5 VDC @1 MHz	安规认证 Agency Approvals		
	V_s	V_s	V	V_a	I_n	I	V_{DC}	IR	C			
	V	V	V	V	kA	A (r.m.s.)	V	G Ω	(pF)	UL497B	UL1449	TUV
SF075A - *	75	57 ~ 93	≤ 650	≈ 8	5	5	50	≥ 1	≤ 1.0	●	N/A	●
SF091A - *	90	72 ~ 108	≤ 700	≈ 8	5	5	50	≥ 1	≤ 1.0	●	N/A	●
SF151A - *	150	120 ~ 180	≤ 700	≈ 8	5	5	50	≥ 1	≤ 1.0	●	N/A	●
SF231A - *	230	184 ~ 280	≤ 700	≈ 10	5	5	100	≥ 1	≤ 1.0	●	N/A	●
SF351A - *	350	280 ~ 420	≤ 1000	≈ 10	5	5	100	≥ 1	≤ 1.0	●	N/A	●
SF471A - *	470	376 ~ 564	≤ 1200	≈ 12	5	5	100	≥ 1	≤ 1.0	●	N/A	●
SF601A - *	600	480 ~ 720	≤ 1400	≈ 15	5	5	100	≥ 1	≤ 1.0	●	N/A	●
SF801A - *	800	640 ~ 960	≤ 1600	≈ 15	5	5	100	≥ 1	≤ 1.0	○	○	●
SF152A - *	1500	1200 ~ 1800	≤ 2400	≈ 15	5	5	100	≥ 1	≤ 1.0	N/A	○	●
SF075M - *	75	57 ~ 93	≤ 650	≈ 8	10	10	50	≥ 1	≤ 1.0	●	N/A	●
SF091M - *	90	72 ~ 108	≤ 700	≈ 15	10	10	50	≥ 1	≤ 1.0	●	N/A	●
SF151M - *	150	120 ~ 180	≤ 700	≈ 15	10	10	50	≥ 1	≤ 1.0	●	N/A	●
SF231M - *	230	184 ~ 280	≤ 700	≈ 15	10	10	100	≥ 1	≤ 1.0	●	N/A	●
SF351M - *	350	280 ~ 420	≤ 1000	≈ 15	10	10	100	≥ 1	≤ 1.0	●	N/A	●
SF471M - *	470	376 ~ 564	≤ 1200	≈ 15	10	10	100	≥ 1	≤ 1.0	●	N/A	●
SF601M - *	600	480 ~ 720	≤ 1400	≈ 15	10	10	100	≥ 1	≤ 1.0	●	N/A	●
SF252T - *	2500	2000 ~ 3000	≤ 4000	≈ 15	3	3	100	≥ 1	≤ 1.0	N/A	●	●
SF302T - *	3000	2400 ~ 3600	≤ 4500	≈ 15	3	3	100	≥ 1	≤ 1.0	N/A	●	●
SF362T - *	3600	2880 ~ 4320	≤ 5000	≈ 15	3	3	100	≥ 1	≤ 1.0	N/A	●	●

备注 Note:

1. 以上参数基于ITU-T K12 & IEC61643.311的标准。The above parameters are based on ITU-T K12 & IEC61643.311 standards.
2. “●”表示产品已通过认证。Means that the product has passed the certification.
“○”表示产品即将申请认证。Means that the product plans to apply for certification.
3. “*”表示不同引脚，“放空”表示无引脚，“L”表示长引脚。
“*” Indicates different pin, such as “null” means no Pin, “L” means straight pin.

击穿电压参考曲线 (参照230 VDC) Performance Curve for Spark-over Voltage

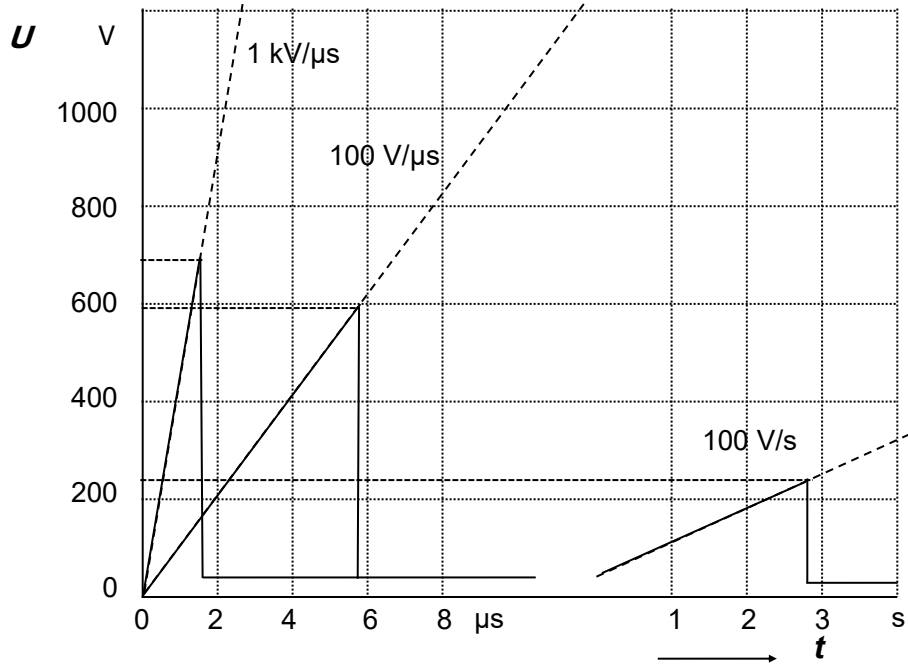

动态响应
Dynamic Response
冲击击穿电压
Impulse Spark-over Voltage
($100\text{ V}/\mu s$ 、 $1\text{ kV}/\mu s$)

静态响应
Static Response
直流击穿电压
D.C. Spark-over Voltage(100 V/s)

冲击电流的参考曲线 Performance Curve for Impulse Discharge Current

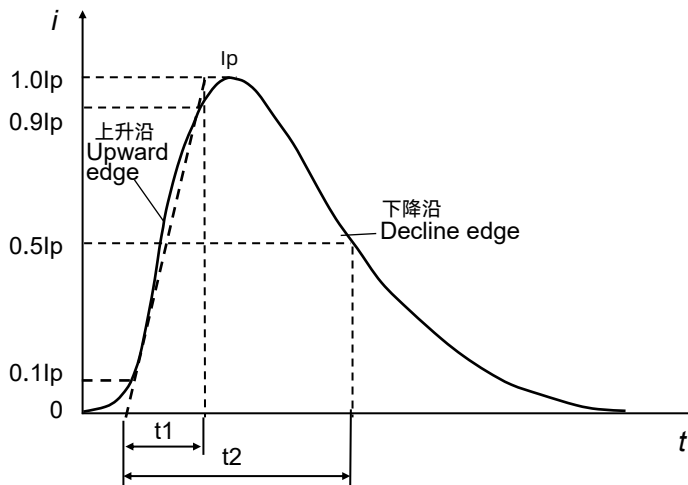

I_p : 峰值电流 Peak current
 t_1 : 上升时间微秒 Rise time in μs
 t_2 : 至半峰值的延迟时间微秒
Decay time to half value in μs

电气特性 Electrical Characteristics

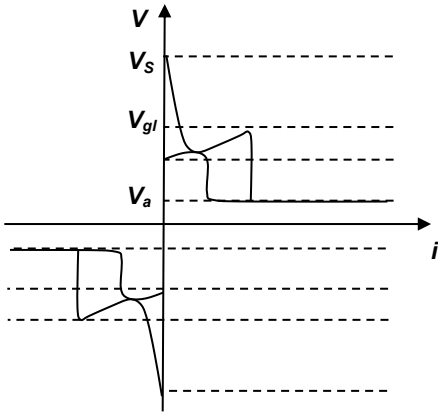

电压和电流之间的关系
Relationship between Current and Voltage

- V_s : 击穿电压 Spark - over Voltage
- V_{gf} : 辉光电压 Glow Voltage
- V_a : 弧光电压 Arc Voltage
- G : 辉光模式 Glow Mode
- A : 弧光模式 Arc Mode

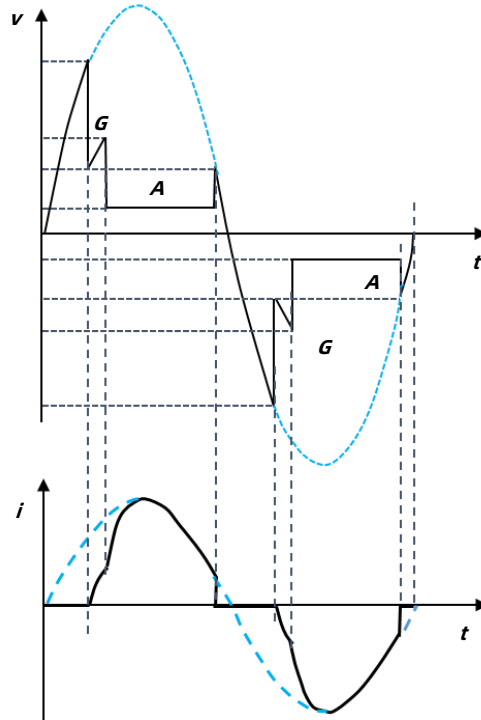

电压和电流的时间变化模式
Time Variation Patterns of Voltage and Current

应用案例 Application Example

交流电源保护 AC Power Protection

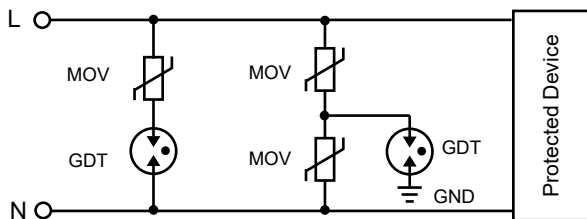

直流电源保护 DC Power Protection

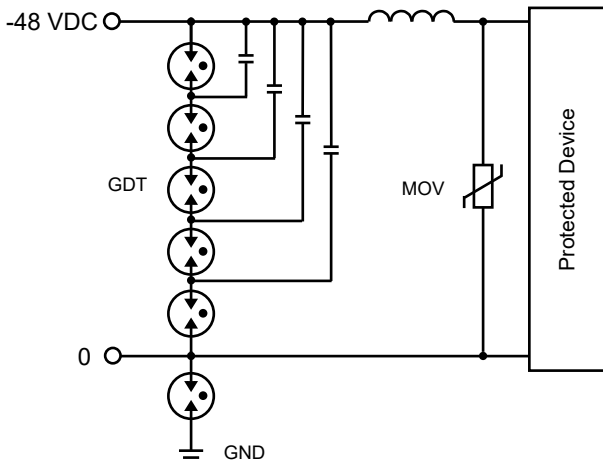

二极气体放电管信号线路保护
2-Electrod GDT Signal Circuit Protection

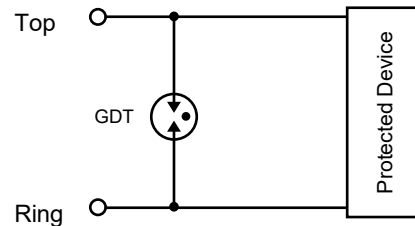

三极气体放电管信号线路保护
3-Electrod GDT Signal Circuit Protection

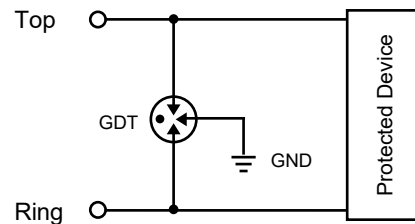

手工焊接推荐参数 Recommended Hand-solder Parameters

项目 Items	条件 Condition
烙铁温度 Iron Temperature	350 °C (Max.)
焊接时间 Soldering Time	4 s (Max.)
焊接点离产品本体位置 Space between Soldering Point and the Bottom of Product	2 mm (Min.)

波峰焊曲线 (参考) Wave Soldering Parameters (Reference)

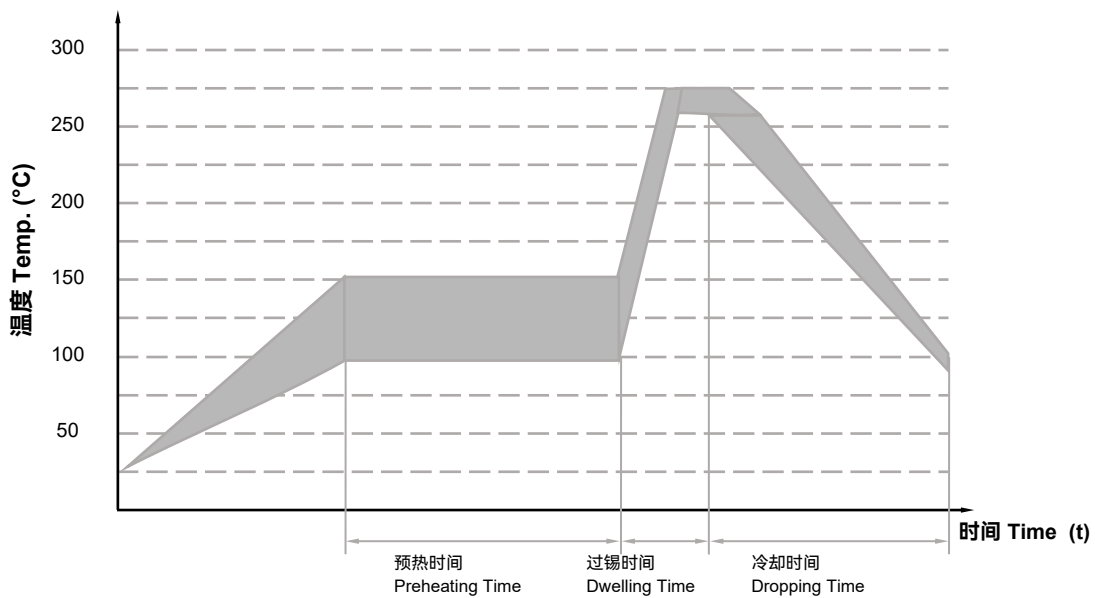

项目 Item	温度 Temp. (°C)	时间 Time (s)
预热 Preheating	90 ~ 150	< 150
过锡 Dwelling	255 ~ 280	3 ~ 10

回流焊参数 (参考) Reflow Soldering Parameters (Reference)

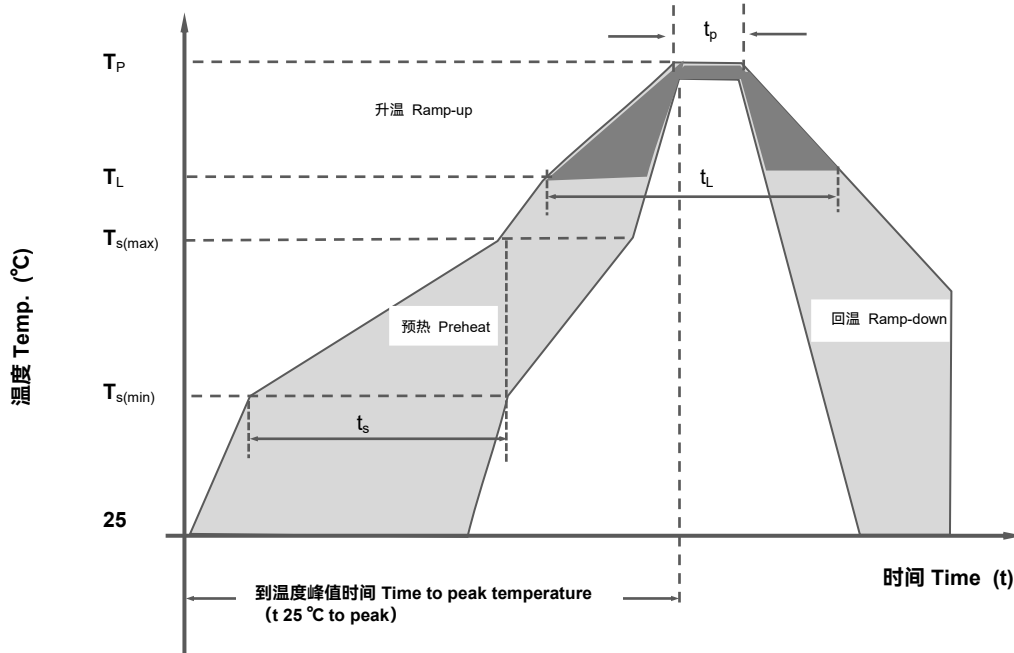

回流焊条件 Reflow Condition		无铅产线 Pb-Free Assembly
预热 Pre Heat	最低温度 Temp. Min $T_{s(min)}$	150 °C
	最高温度 Temp. Max $T_{s(max)}$	200 °C
	最低温到最高温时间 Time (Min to Max) t_s	(60 ~ 180) s
平均升温率(熔化温度至峰值) Average ramp up rate (Liquidus Temp (T_L) to peak)		3 °C/second max
预热温区升温率 $T_{s(max)}$ to T_L Ramp-up Rate		5 °C/second max
回流焊 Re-flow	熔化温度 Temperature (T_L) (Liquidus)	217 °C
	熔化时间 Temperature (t_L)	(60 ~ 150) s
最高温度 Peak Temperature (T_P)		(255 ~ 260) °C
最高温度的维持时间 Time within 5 °C of actual peak Temperature (t_p)		≈ 10 s
回温速率 Ramp-down Rate		6 °C/second max
从25 °C到最高温度时间 Time 25 °C to peak Temperature (T_P)		8 minutes max
不超过 Do not exceed		260 °C

包装信息 Packaging Information

吸塑盒包装 PC Box Type

项次 Item	吸塑盒 PC Box	内箱 Inner	外箱 Carton
尺寸 Dimensions (mm)	215 × 205 × 6.5	230 × 210 × 60	480 × 230 × 320
数量 Quantity (PCS)	100	500	5000
备注：包装尺寸与数量仅供参考。 Remark: The dimensions and quantity of packaging is for reference only.			

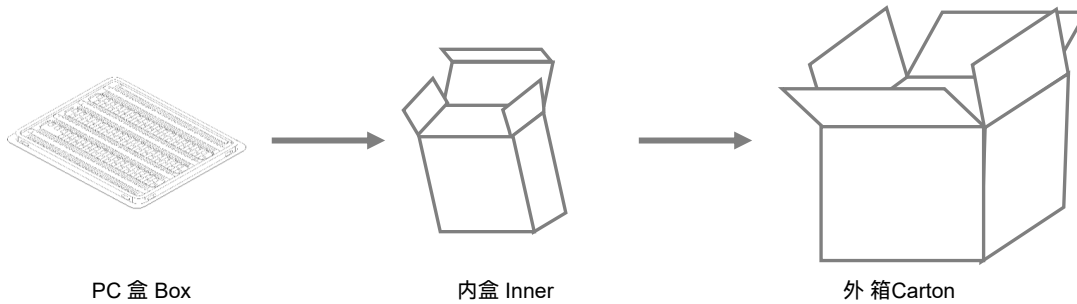

请参考技术规格书的包装信息。Please refer to the specifications for the packaging details.

编带包装 Braid type

项次 Item	卷盘 Reel	外箱 Carton
尺寸 Dimensions (mm)	Φ340 × 73	360 × 360 × 360
数量 Quantity (PCS)	1250	5000
备注：包装尺寸与数量仅供参考。 Remark: The dimensions and quantity of packaging is for reference only.		

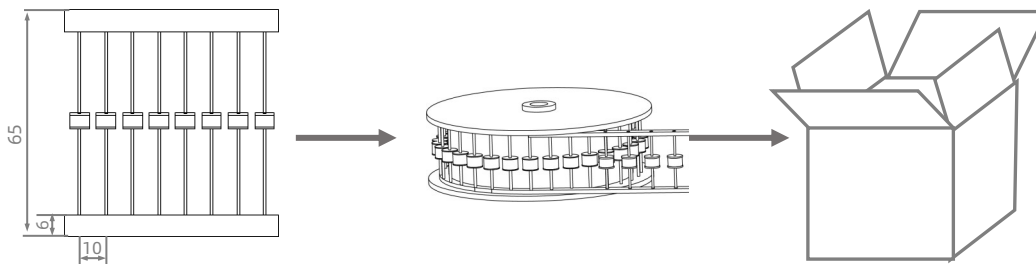

单位 Unit: mm;

请参考技术规格书的包装信息Please refer to the specifications for the packaging details.



注意

ATTENTION

使用方法 Usage

1. 在电源线路中最大运行电压超过气体放电管的最小开启电压，不能使用气体放电管。
Do not operate gas discharge tube in power supply networks, whose maximum operation voltage exceeds the minimum Spark - overvoltage of the gas discharge tube.
2. 气体放电管在长时间电流压力下会变热（起火），这种过载将使连接器失效或器件损坏。
Gas discharge tube may become hot in the event of longer periods of current stress (burn risk). In the event of overload the connectors may fail or the component may be destroyed.
3. 如果气体放电管的接触有缺陷，超载的电流能引产生火花和大的噪音。
If the contacts of the surge arresters are defective, current load can cause sparks and loud noises.
4. 气压在55 kPa 到106 kPa，对应海拔为+5000 m到- 500 m。
Air pressure is 55 kPa to 106 kPa. These values represent an altitude of +5000 m to -500 m, respectively.

更换 Replace

气体放电管是不可返修的产品,安全起见，建议采用同类型产品进行更换。
GDT is a non-repairable product. For safety sake, please use equivalent GDT for replacement.

存贮 Storage

要包装好的放电管应置于干燥、通风和无腐蚀的环境中。
The packaged GDT should be placed in a dry, ventilation and non-corrosive environment.

安装位置 Installation Position

不要将陶瓷气体放电管安装在人体可碰触到的位置。
Do not install the GDT where the human body may touch it.

机械应力 Mechanical Stress

装配时不要采取敲击等暴力动作，以免产品失效。
Do not take violent action such as knocking when assembling to avoid product failure.