

热保护型熔断电阻器

Thermal-Link & Fusing Resistor (TRXF)

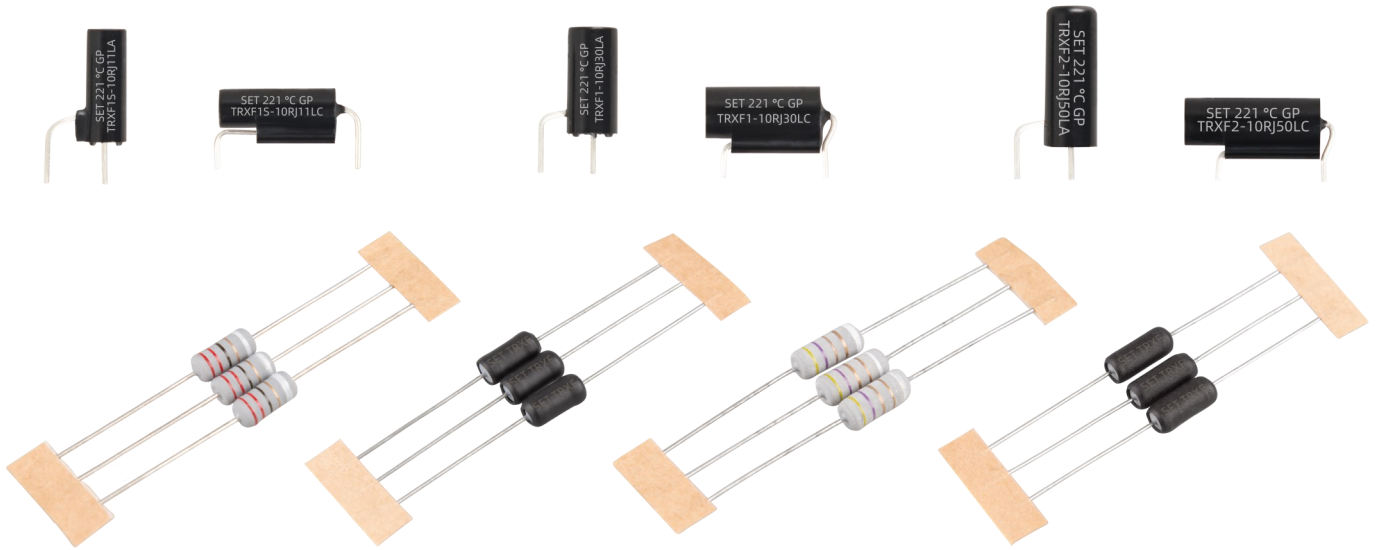

特征 Features

- 专利产品
- 过流保护
- 过温保护
- 抗雷击
- 开机浪涌保护
- 小故障电流保护
- 短路保护
- 环保型产品

- Patented Product
- Over Current Protection
- Over Temp. Protection
- Surge Protection
- Inrush Current Protection
- Small Fault Current Protection
- Short Circuit Protection
- RoHS & REACH Complaint







热保护型熔断电阻器

Thermal-Link & Fusing Resistor (TRXF)

TRXF

热保护型熔断电阻器 (外壳型) 特征概览

Thermal-Link & Fusing Resistor (TRXF-Case Type) Features Overview

外形 Shape	立式 Vertical	卧式 Horizontal	立式 Vertical	卧式 Horizontal	立式 Vertical	卧式 Horizontal
						
结构 Structure	立式 Vertical	卧式 Horizontal	立式 Vertical	卧式 Horizontal	立式 Vertical	卧式 Horizontal
R 阻值 Resistance Range	1.0 Ω - 600 Ω		0.27 Ω - 800 Ω		0.27 Ω - 1000 Ω	
P 功率类型 Power Type	1 W(S)		1 W		2 W	
尺寸 Dimensions	Φ3.6 mm × 11.0 mm		Φ4.8 mm × 11.0 mm		Φ4.8 mm × 13.5 mm	
T_f 额定动作温度 Rated Functioning Temp.	145 °C, 150 °C, 221 °C					

参照标准: IEC60063-2015, 阻值可根据客户需求定制。
According to IEC60063-2015, resistance can be customized.

引脚成型方式及尺寸可根据客户需求定制。
The forming modes and length of lead wires can be customized.

TRXF

热保护型熔断电阻器

Thermal-Link & Fusing Resistor (TRXF)

TRXF

热保护型熔断电阻器 (轴向型) 特征概览
Thermal-Link & Fusing Resistor (TRXF-Axial Type) Features Overview

<p>页码 Page</p>	
<p>外形 Shape</p>	
<p>结构 Structure</p>	<p>涂覆型 Coating</p> <p>套管型 With Tube</p> <p>涂覆型 Coating</p> <p>套管型 With Tube</p>
<p>R 阻值 Resistance Range</p>	<p>0.27 Ω - 800 Ω</p> <p>0.27 Ω - 1000 Ω</p>
<p>P 功率类型 Power Type</p>	<p>1 W</p> <p>2 W</p>
<p>尺寸 Dimensions</p>	<p>Φ4.4 mm × 9.0 mm</p> <p>Φ4.6 mm × 9.5 mm</p> <p>Φ4.4 mm × 10 mm</p> <p>Φ4.6 mm × 10.5 mm</p>
<p>T_f 额定动作温度 Rated Functioning Temp.</p>	<p>221 °C</p>

参照标准: IEC60063-2015, 阻值可根据客户需求定制。
According to IEC60063-2015, resistance can be customized.

引脚成型方式及尺寸可根据客户需求定制。
The forming modes and length of lead wires can be customized.

TRXF

热保护型熔断电阻器

Thermal-Link & Fusing Resistor (TRXF)

产品描述 Description

热保护型熔断电阻器 (TRXF) 是一种同时具有过温，过流保护功能的功率型电阻器。该产品是将合金型温度保险丝 (ATCO) 内置于线绕熔断电阻器 (RXF) 之中，并形成串联连接。赛尔特公司 (SETsafe | SETfuse) 热保护型熔断电阻器不仅具有与普通线绕熔断电阻器相同的小尺寸和大故障电流保护功能，还可有效解决普通线绕熔断电阻器在小故障电流下所产生异常持续高温的安全隐患。

Thermal-Link & Fusing Resistor (TRXF) is an unique type of Power Resistor, with Over Temp. and Over Current Protections. The Alloy Thermal-Link (ATCO) is built in the core of Fusible Wirewound Resistor (RXF) and in series with RXF.

SETsafe | SETfuse TRXF has the same physical size as ordinary RXF as well as large fault current protection. Besides, TRXF can effectively solve the hidden danger of continuous abnormal heat that ordinary RXF may cause when small fault current happens.

应用 Applications

- | | |
|----------|---------------------------|
| ● 电源 | Power Supply |
| ● 通用照明 | General Lighting |
| ● 插座 | Power Strip |
| ● 个人护理电器 | Personal Care Application |
| ● 智能家居 | Smart Home |
| ● 安防 | Security & Protection |

结构图 Structure

外壳型 Case Type

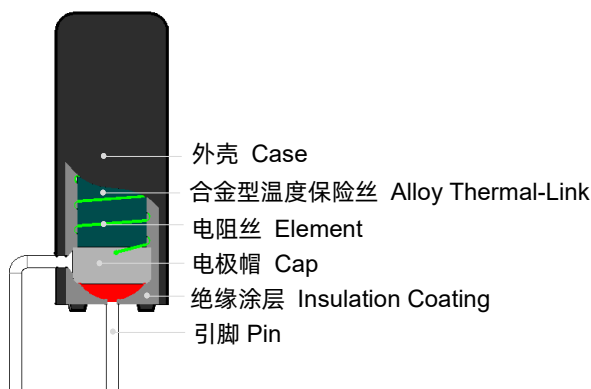

轴向型 Axial Type

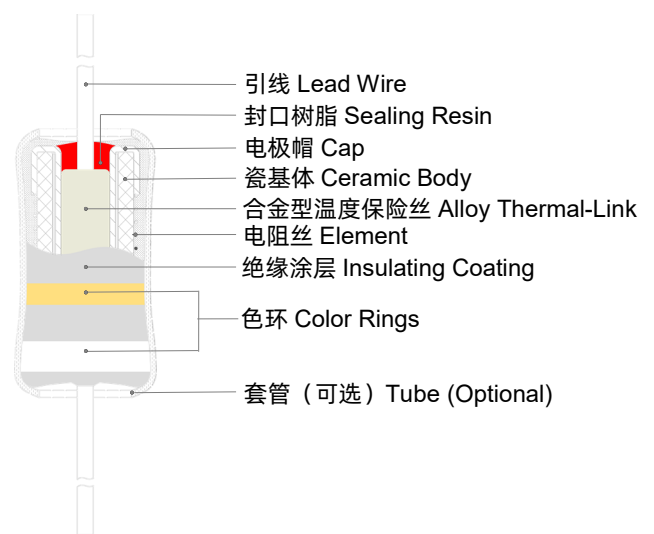

备注：示意图颜色仅供参考

Note: The color of schematic diagram is for reference only

TRXF

TRXF

热保护型熔断电阻器

Thermal-Link & Fusing Resistor (TRXF)

型号说明 Product Number System

● 外壳型 Case Type

TRXF 1 - 4R7 J 30 L A

外壳类型 Case Type

- A: 圆形 Round
- C: Ω形 Shape

引出脚类型 Pin Type

- L: 二只脚 Two Pins

温度保险丝代码 ATCO Code

TRXF1S 系列 Series		TRXF1 系列 Series		TRXF2 系列 Series	
代码 Code	ATCO 型号 Model	代码 Code	ATCO 型号 Model	代码 Code	ATCO 型号 Model
07	V6 (145 °C)	26	H6 (145 °C)	46	B6 (145 °C)
08	V7 (150 °C)	27	H7 (150 °C)	47	B7 (150 °C)
11	V31 (221 °C)	30	H31 (221 °C)	50	B31 (221 °C)

阻值公差 Resistance Tolerance (%)

- J: ± 5
- K: ± 10

标称阻值 Rated Resistance (Ω)

- R47: 0.47
- 4R7: 4.7
- 47R: 47
- 470R: 470

功率类型 Power Type (W)

- 1S: 1
- 1: 1
- 2: 2

产品类别 Product Category

TRXF: 热保护型熔断电阻器
Thermal-Link & Fusing Resistor

TRXF

TRXF

热保护型熔断电阻器

Thermal-Link & Fusing Resistor (TRXF)

型号说明 Product Number System

● 轴向型 Axial Type

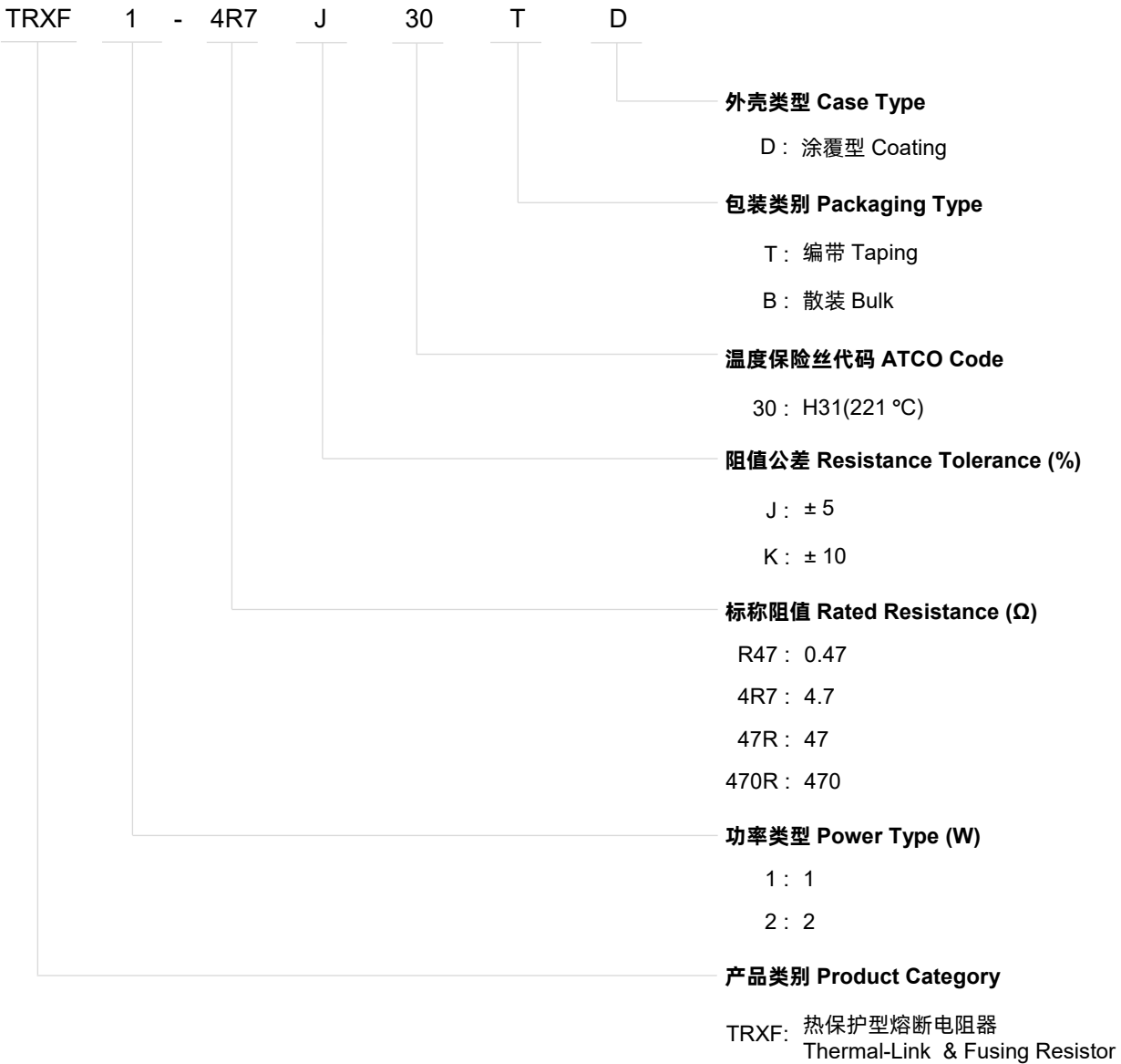

TRXF

TRXF

热保护型熔断电阻器

Thermal-Link & Fusing Resistor (TRXF)

应用对比 Application Comparison

RXF

安全隐患
Security Risks

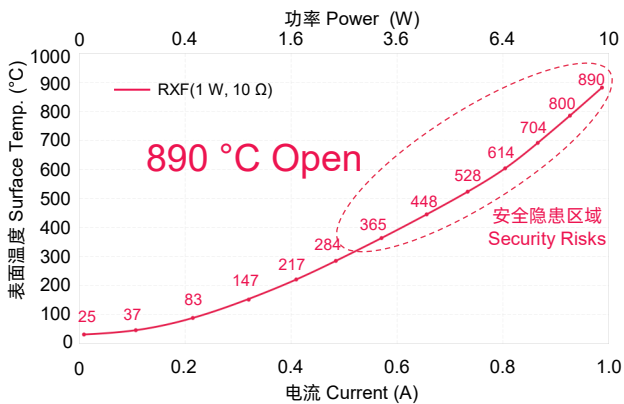
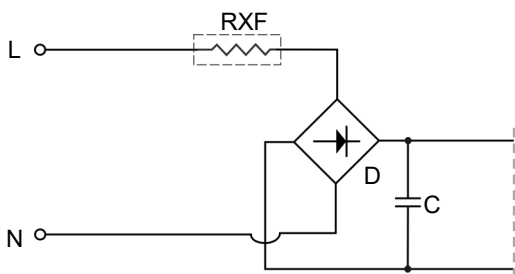

RXF表面温度曲线(仅供参考)
Surface Temp. Curve of RXF (For reference only)

备注：温度表实测数据 Note: Measuring with Thermometer



0.9 A / 8.1 W

备注：FLUKE红外热像仪实测图片(型号：iT27, -20 °C ~ 600 °C)
Note: Measuring with FLUKE Infrared Meter (iT27, -20 °C ~ 600 °C)

TRXF

安全
Safety

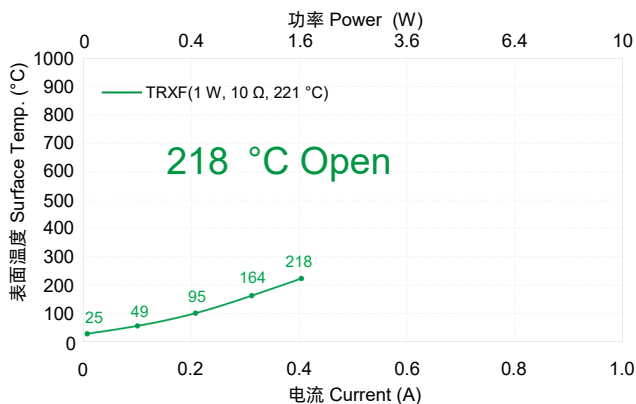
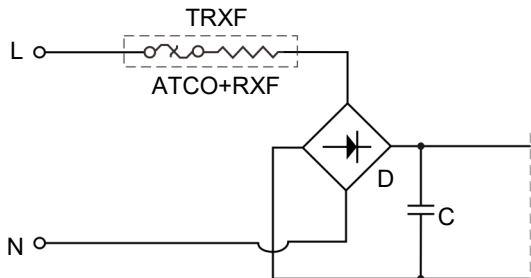
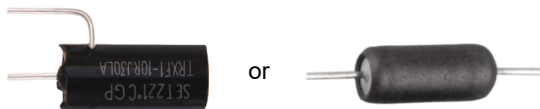

TRXF表面温度曲线(仅供参考)
Surface Temp. Curve of TRXF (For reference only)

备注：温度表实测数据 Note: Measuring with Thermometer

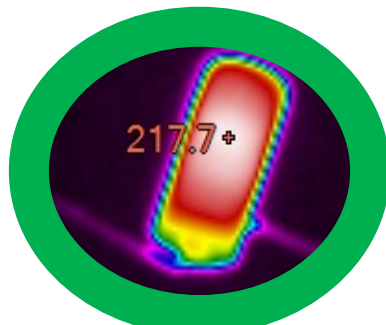

0.4 A / 1.6 W

备注：FLUKE红外热像仪实测图片(型号：iT27, -20 °C ~ 600 °C)
Note: Measuring with FLUKE Infrared Meter (iT27, -20 °C ~ 600 °C)

热保护型熔断电阻器

Thermal-Link & Fusing Resistor (TRXF)

开关电源保护应用比较 Comparison for SMPS Applications

保护元件 Protective Component		短路保护 Short Circuit Protection	小故障电流保护 Small Fault Current Protection	浪涌防护 Surge Protection	开机浪涌保护 Inrush Current Protection
电流保险丝 Fuse		一般 Common	一般 Common	差 Poor	差 Poor
		短路抗爆性 Anti-explosion Capacity	无着火风险 No Fire Risk	自身可承受一定的浪涌冲击, 但对后端元器件保护能力弱 Fuse - Common, Back-end Components Protection - Poor	自身可承受一定的浪涌冲击, 但对后端元器件保护能力弱 Fuse - Common, Back-end Components Protection - Poor
电流保险丝 + 热敏电阻 Fuse + NTC		一般 Common	好 Good	一般 Common	热态一般, 冷态良好 Hot State - Common, Cold State - Good
		短路抗爆性 Anti-explosion Capacity	无着火风险 No Fire Risk	/	/
电流保险丝 + 热敏电阻 + 压敏电阻 Fuse + NTC + MOV		一般 Common	好 Good	优异 Excellent	热态一般, 冷态良好 Hot State - Common, Cold State - Good
		短路抗爆性 Anti-explosion Capacity	无着火风险 No Fire Risk	/	/
线绕熔断电阻器 RXF		一般 Common	差 Poor	好 Good	好 Good
		短路抗爆性 Anti-explosion Capacity	存在着火风险 Fire Risk	≥2 kV	/
热保护型熔断电阻器 TRXF		优异 Excellent	优异 Excellent	好 Good	好 Good
		良好的短路抗爆性 Good Anti-explosion Capacity	无着火风险 No Fire Risk	≥2 kV	/

TRXF

TRXF

热保护型熔断电阻器

Thermal-Link & Fusing Resistor (TRXF)

产品标示 Marking

● 外壳型 Case Type

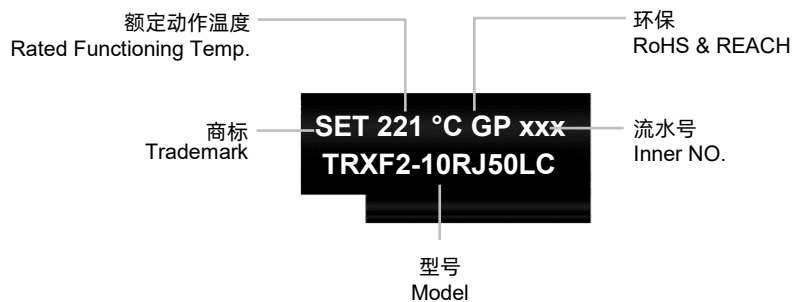

● 轴向型 Axial Type

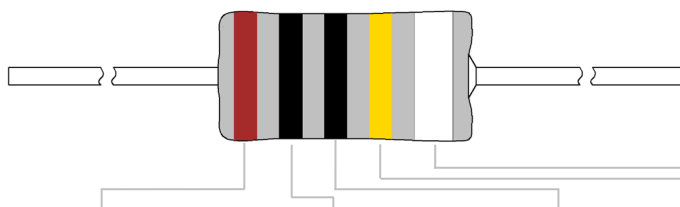

颜色 Color		第一位有效数字 The First Number	第二位有效数字 The Second Number	倍率 Multiple	阻值公差 Resistance Tolerance	额定动作温度 T_f
■	黑 Black	0	0	10^0	N/A	N/A
■	棕 Brown	1	1	10^1	N/A	N/A
■	红 Red	2	2	10^2	N/A	N/A
■	橙 Orange	3	3	10^3	N/A	N/A
■	黄 Yellow	4	4	10^4	N/A	N/A
■	绿 Green	5	5	10^5	N/A	N/A
■	蓝 Blue	6	6	10^6	N/A	N/A
■	紫 Purple	7	7	10^7	N/A	N/A
■	灰 Grey	8	8	10^8	N/A	N/A
□	白 White	9	9	10^9	N/A	221 °C
■	金 Gold	N/A	N/A	10^{-1}	J: ± 5%	N/A
■	银 Silver	N/A	N/A	10^{-2}	K: ± 10%	N/A





热保护型熔断电阻器

Thermal-Link & Fusing Resistor (TRXF)

产品专利 Patents

名称 Name	区域 Region	专利类别 Category	专利号 Patent NO.
一种温度保险丝与电阻结合的装置 A Device that Combines Thermal-link and Resistor	中国 China	实用新型 Utility Model	ZL 201020697438.7
	美国 United States	发明专利 Invention Patent	US 9240300
一种热保护型电阻 Thermal Fuse Resistor	中国 China	实用新型 Utility Model	ZL2016212458250
	美国 United States	发明专利 Invention Patent	US10347402

认证信息 Agency Approvals

认证信息 Agency Information		标准 Standards	文件号 NO.
	cURus	UL 1412	E324712
	UL	UL 1412	E324712
	TUV	IEC 60065 EN IEC 60127-8	R50279979 R50560298 R50560302
	CQC	SJ 2865	CQC15001126561 CQC15001126562 CQC15001126563 CQC18001205501 CQC18001205502

执行标准 Designed to Standards

标准 Standards	标准名 Standards Name
IEC 60115	Fixed Resistors for Use in Electronic Equipment
IEC 60065	Audio, Video and Similar Electric Apparatus – Safety Requirements
UL 60691	Thermal-Links – Requirements and Application Guide
UL1412	Fusing Resistors and Temperature-Limited Resistors for Radio- and Television-Type Appliances
GB/T 9816	《热熔断体的要求和应用导则》 Thermal-Links-Requirements and Application Guide
GB/T 17626.5	《电磁兼容试验和测量技术浪涌(冲击)抗扰度试验》 Electromagnetic Compatibility-Testing and Measurement Techniques-Surge Immunity Test
GB/T 5729	《电子设备用固定电阻器总规范》 Fixed Resistors for Use in Electronic Equipment
SJ 2865	《电子元件详细规范》 Detail Specification for Electronic Components

热保护型熔断电阻器

Thermal-Link & Fusing Resistor (TRXF)

术语 Glossary

项目 Item	描述 Description
RXF	<p>线绕熔断电阻器 Fusible Wirewound Resistor</p> <p>电阻丝绕在瓷基体上再经过绝缘封装处理而成的功率型电阻器。当通过电流超过预定值时，能在预定的时间切断电流。线绕熔断电阻器为一次性熔断元件，不可恢复。 — (SETsafe SETfuse 企业标准)</p> <p>A power resistor which is made by winding a resistive element on a ceramic core, and the core is coated by insulation coating. It intends to interrupt a current flow at a predetermined time when the current exceeds a predetermined value. Fusible Wirewound Resistor is disposable fuse elements and is non-recoverable. — (SETsafe SETfuse Standards)</p>
ATCO	<p>合金型温度保险丝 Alloy Thermal-Link</p> <p>合金型温度保险丝，由易熔合金作为感温部件的热熔断体。 — (GB/T 9816.3)</p> <p>Alloy Type Thermal-Link, Alloy is the thermal element.</p>
R	<p>标称阻值 Rated Resistance</p> <p>电阻器设计所确定的，通常在电阻器上标出的阻值。 — (GB/T 5729)</p> <p>Resistance value for which the resistor has been designed, and which is generally used for denomination of the resistor. — (IEC 60115-1)</p>
P ₀	<p>实际功率 Actual Power</p> <p>在允许的工作温度范围内，TRXF可使用的最大功率。 — (SETsafe SETfuse 企业标准)</p> <p>The Max. power of TRXF can be used within the allowable operating Temp. range. — (SETsafe SETfuse Standards)</p>
I _N	<p>额定电流 Rated Current</p> <p>$I_N = \sqrt{P_0 / R}$ — (SETsafe SETfuse Standards)</p>
U _N	<p>额定电压 Rated Voltage</p> <p>用标称阻值和额定功耗乘积的平方根计算出来的直流电压或交流电压有效值。 — (GB/T 5729)</p> <p>The d.c. or a.c. r.m.s. voltage calculated from the square root of the product of the rated resistance and the rated dissipation. — (IEC 60115-1)</p>
T _f	<p>额定动作温度 Rated Functioning Temp.</p> <p>在仅通以不超过10 mA的探测电流的条件下，测得的使热熔断体导电状态改变的温度。 — (GB 9816.1)</p> <p>The temp. of the Alloy Thermal-Link which causes it to change the state of conductivity with a detection current up to 10 mA as the only load. — (IEC 60691)</p> <p>允许偏差 Tolerance: T_f + 0 / -10 °C (GB 9816.1, EN 60691, K60691)</p> <p>允许偏差 Tolerance: T_f ± 7 °C (J60691)</p>
Fusing Temp.	<p>实测熔断温度 Fusing Temp.</p> <p>置于油池中，通10 mA以下的负载电流，每分钟升温0.5 °C ~ 1 °C，测断开温度。 — (GB 9816.1)</p> <p>The temp. of the Alloy Thermal-Link which causes it to change its state of conductivity is measured with silicone oil bath in which the temp. is increased at the rate of 0.5 °C to 1 °C / minute, with a detection current up to 10 mA as the only load. — (IEC 60691)</p>
TCR	<p>电阻温度系数 Temp. Coefficient of Resistance</p> <p>两个规定温度之间的阻值相对变化除以产生这个变化的温度之差。 — (GB/T 5729)</p> <p>Relative variation of resistance between two given temp. divided by the difference in the temp. producing it. — (IEC60115-1)</p>

热保护型熔断电阻器

Thermal-Link & Fusing Resistor (TRXF)

工作原理 Operating Principle

说明 Instruction

$$R_{RXF} \geq 100R_{ATCO}$$

- R_{RXF} : 线绕熔断电阻器的阻值
 R_{RXF} : the resistance value of RXF
- R_{ATCO} : 合金型温度保险丝的阻值
 R_{ATCO} : the resistance value of Alloy Thermal-Link (ATCO)

$$T_{RXF} \geq 5T_{ATCO}$$

- 电阻丝的断开温度 (T_{RXF}) 为 $1200^{\circ}\text{C} \sim 1500^{\circ}\text{C}$
The Fusing Temp. of RXF (T_{RXF}): $1200^{\circ}\text{C} \sim 1500^{\circ}\text{C}$
- 合金型温度保险丝断开温度 (T_{ATCO}) 为 $145^{\circ}\text{C} \sim 221^{\circ}\text{C}$
The Fusing Temp. of ATCO (T_{ATCO}): $145^{\circ}\text{C} \sim 221^{\circ}\text{C}$

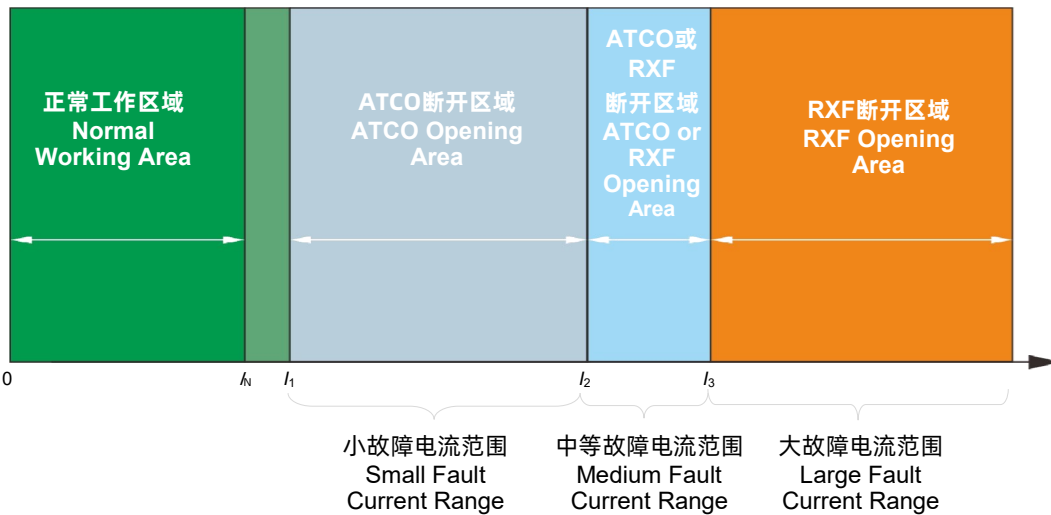
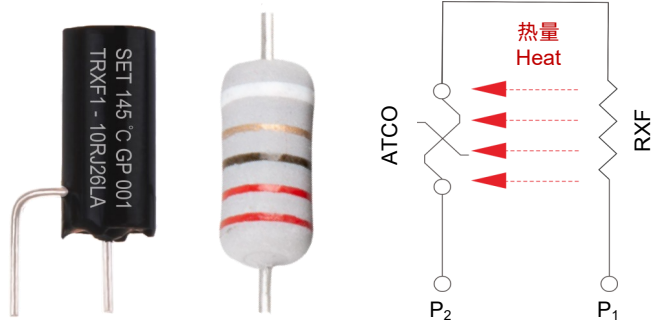

I_N : 额定电流 Rated Current

I_1 : 临界熔断电流 Conventional Fusing Current

● 小故障电流保护原理 Small Fault Current Protection

小故障电流下，即 $I_1 < I < I_2$ 时，RXF发热并将热量传递给ATCO，当达到ATCO的熔断温度时，ATCO断开，从而起到保护电路的作用。即在小故障电流下，RXF未断开，ATCO断开。

Under small fault current, $I_1 < I < I_2$, ATCO senses the heat that generated by RXF. When the ATCO reaches the fusing temp., ATCO opens the circuit quickly. In this case, RXF keeps intact and ATCO opens.

● 中等故障电流保护原理 Medium Fault Current Protection

中等故障电流下，即 $I_2 < I < I_3$ 时，因发热功率大，RXF在较短时间内发生熔断，其断开过程产生的余热使得ATCO熔断。即在中等故障电流下，RXF & ATCO 均断开。

Under medium fault current, $I_2 < I < I_3$, RXF opens in a short time due to the large heat generated, meanwhile, RXF conducts its residual heat to ATCO. In this case, both RXF and ATCO open.

● 大故障电流保护原理 Large Fault Current Protection (Short Circuit Protection)

大故障电流下，即 $I > I_3$ 时，如出现电路短路，RXF瞬间断开。因断开时间极短，其产生的热量不足以将ATCO熔断。即在大故障电流下，RXF断开，ATCO未断开。

Under large fault current, $I > I_3$, such as short circuit, RXF opens instantly, but ATCO keeps intact because the fusing time of RXF is too short to generate enough heat. In this case, RXF opens and ATCO keeps intact.

热保护型熔断电阻器

Thermal-Link & Fusing Resistor (TRXF)

性能测试 Performance Test

机械性能测试 Mechanical Performance Test

项目 Item	试验条件 Test Condition	判定标准 Criterion
拉力测试 Tensile Test	对引线施加10 N的拉力，保持60 s。 A pin withstand 10 N × 60 s	无可见损伤 No Visible Damage $\Delta R \leq \pm (1\%R + 0.05 \Omega)$
扭转测试 Twist Test	引脚从根部折弯90°（折弯位置距本体2 mm），扭转180° × 2次。 A pin 2 mm away from body, bent 90°, twist 180° × 2 times.	无可见损伤 No Visible Damage $\Delta R \leq \pm (1\%R + 0.05 \Omega)$

环境试验 Environmental Test

项目 Item	试验条件 Test Condition	判定标准 Criterion
温度循环 Temp. Cycle	1. - 55 °C × 30 minutes 2. 室温 Room Temp. × (10 ~ 15) minutes 3. 85 °C × 30 minutes 4. 室温 Room Temp. × (10 ~ 15) minutes 5. 步骤1至4循环5次 5 Cycles from Step 1 to Step 4	$\Delta R \leq \pm (2\%R + 0.05 \Omega)$

电气特性测试 Electrical Performance Test

项目 Item	试验条件 Test Condition	判定标准 Criterion
电阻温度系数 TCR	$TCR = \frac{R_2 - R_1}{R_1(T_2 - T_1)} \times 10^6$ R ₁ : 25 °C时的电阻值 Resistance Value at 25 °C R ₂ : 125 °C时的电阻值 Resistance Value at 125 °C T ₁ : 25 °C, T ₂ : 125 °C	在规定值范围内 Within Specified Value
短时间过载 Short-Time Overload	通2.5倍的额定电压，持续5 s。 2.5U _N × 5 s	无可见损伤 No Visible Damage $\Delta R \leq \pm (2\%R + 0.05 \Omega)$
绝缘电阻 Insulation Resistance	包箔法，在引线与金属膜之间施加500 VDC。 Foil Method: Apply 500 VDC between both terminations of the resistor connected together as one pole and the metal foil as the other pole.	绝缘电阻：≥1,000 MΩ Insulation Resistance ≥ 1,000 MΩ
耐电压 Voltage Proof	包箔法，引线与金属箔膜之间施加350 VAC（涂覆型）或900 VAC（外壳型，套管型），保持1 minute。 Foil Method: Apply 350 VAC × 1 minute (coating type) or 900 VAC × 1 minute (case type, tube type) between terminations and the metal foil.	不得有弧光、击穿等现象发生 No Breakdown or Flashover
熔断测试 Fusing Test	对电阻器施加规定的测试电流（恒流源） Apply specified test current to the resistor (constant current source).	温度保险丝熔断时间 ≤ 60 s Fusing Time ≤ 60 s

热保护型熔断电阻器

Thermal-Link & Fusing Resistor (TRXF)

电气特性测试 Electrical Performance Test

项目 Item	测试条件 Test Condition	判定标准 Criterion
可焊性 Solderability	槽焊法（非活性松香） 助焊剂：25%松香酒精 锡炉温度：(255 ± 5) °C 浸入深度（距安装面或元件主体）：(1.5 ~ 2.0) mm 浸入时间：(2.5 ± 0.5) s Solder Bath (non-activated flux) Soldering Powder: 25% Rosin Alcohol Bath Temp.: (255 ± 5) °C Depth of Immersion (From the seating plane or component body): (1.5 to 2.0) mm Time of Immersion: (2.5 ± 0.5) s	引线焊锡面积覆盖率≥95% Soldering Area ≥ 95%
雷击浪涌测试 Surge Test	使用组合波发生器 (1.2/50 μs, 8/20 μs, 2 Ω)对电阻器施加开路电压1.0 kV (R ≤ 10 Ω) 或 2.0 kV (R > 10 Ω) ，冲击10次，间隔1 minute。 Combination Wave Generator (1.2/50 μs, 8/20 μs, 2 Ω), apply open-circuit voltage 1.0 kV (R ≤ 10 Ω) or 2.0 kV (R > 10 Ω) to the resistor, 10 pulses test at 1 minute Interval.	试验后电阻无开路。 Resistor shall not open after the test
实测熔断温度 Fusing Temp.	产品置于油池，通10 mA以下的负载电流，每分钟升温0.3 °C ~ 0.5 °C，测断开温度。 Silicone oil bath: temp. rise rate is 0.3 °C/minute to 0.5 °C/minute, detection current ≤ 10 mA.	216 °C to 221 °C (T _f = 221 °C) 143 °C to 147 °C (T _f = 150 °C) 138 °C to 142 °C (T _f = 145 °C)

TRXF

TRXF

热保护型熔断电阻器

Thermal-Link & Fusing Resistor (TRXF)



注意 ATTENTION

冷电阻测试 Cold Resistance Test

1. 当产品电阻温度系数 ≥ 350 ($10^{-6}/^{\circ}\text{C}$), 对产品进行电阻测试时, 需要用电阻温度系数将阻值修正至基准温度 25°C 所对应的电阻值。
If product TCR is not less than 350 ($10^{-6}/^{\circ}\text{C}$), the measured resistance value shall be corrected as the relative resistance value under 25°C according to TCR formula.
2. 采用四端测试法
Resistance Measurement (4-terminal test)

更换 Replacement

热保护型熔断电阻器是不可修复的产品, 基于安全原因, 替换时应使用同类别同型号的产品。
As TRXF is a non-resettable product, for safety sake, please use the same type of TRXF for replacement.

使用方法 Usage

1. 通电情况下请勿用人体直接触碰电阻器本体或引脚, 防止烫伤或触电。
Do not touch the resistor body or pins directly when power is on, to avoid burn or electric shock.
2. 气压在 80 kPa 到 106 kPa , 对应海拔为 $+2000\text{ m}$ 到 -500 m 。
When air pressure is from 80 kPa to 106 kPa , the relative altitude shall be $+2000\text{ m}$ to -500 m .

贮存 Storage

1. 将热保护型熔断电阻器放置在温度 10°C ~ 30°C , 相对湿度 30% ~ 75% 的条件下保存。
Please store TRXF with ambient temp. 10°C ~ 30°C and relative humidity 30% ~ 75% .
2. 热保护型熔断电阻器的贮存应避免高温、高湿、日光直射及腐蚀性气体的场合, 避免影响引脚的可焊性, 产品购入后请于1年内使用完毕。
Do not store the TRXF at the high temp., high humidity or corrosive gas environment, avoid influencing the solderability of the pins, please use them up within 1 year after receiving the goods.

热保护型熔断电阻器

Thermal-Link & Fusing Resistor (TRXF)

焊接参数 Soldering Parameters

波峰焊参数 (仅供参考) Wave Soldering Parameters (For Reference Only)

波峰焊参数仅供参考, 在TRXF实际应用前, 推荐进行相关验证。

The Wave Soldering Parameters are for reference only, before TRXF is for practice usage, relative validation is recommended.

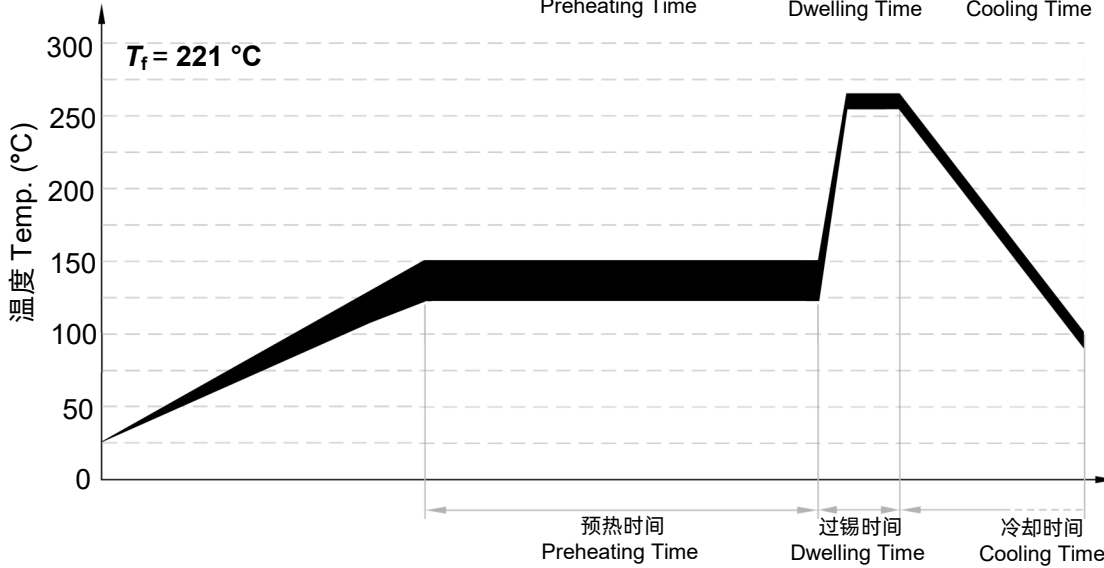
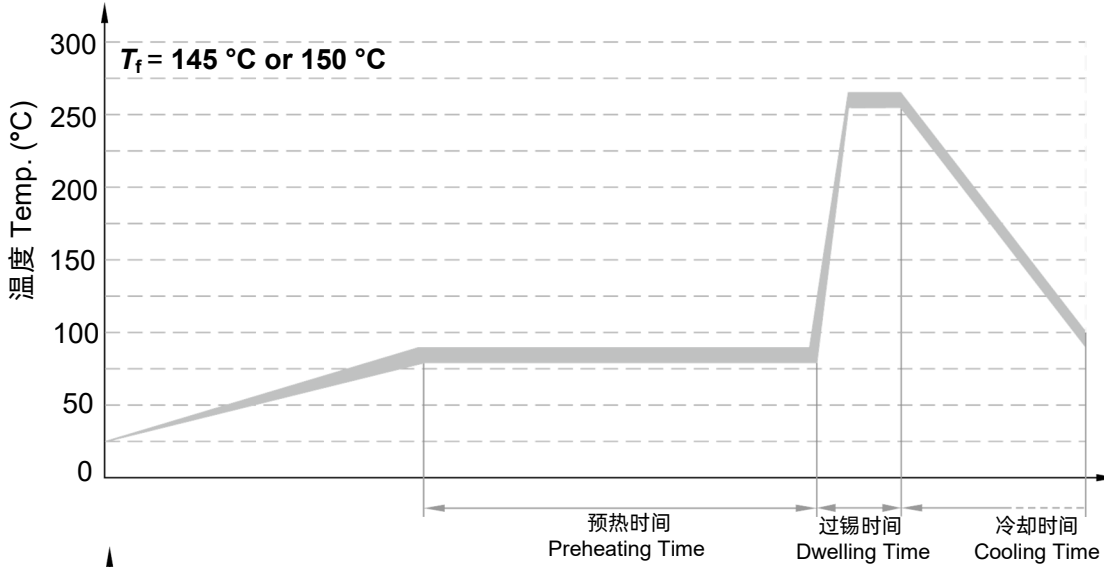

项目 Item	温度 Temp. (°C)		时间 Time (s)
	$T_f=145^\circ\text{C or } 150^\circ\text{C}$	$T_f=221^\circ\text{C}$	
预热 Preheating	80 ~ 90	120 ~ 150	60 ~ 100
过锡 Dwelling	260 ± 5	260 ± 5	4 ~ 5

推荐的手工焊参数 Recommended Hand-Soldering Parameters

烙铁温度 Solder Iron Temp.: $(350 \pm 5)^\circ\text{C}$

焊接时间 Soldering Time: 2 s Max. ($115^\circ\text{C} \leq T_f \leq 150^\circ\text{C}$)

3 s Max. ($T_f = 221^\circ\text{C}$)

热保护型熔断电阻器

Thermal-Link & Fusing Resistor (TRXF)

TRXF1 系列 Series

立式 Vertical



尺寸 Dimensions (mm)

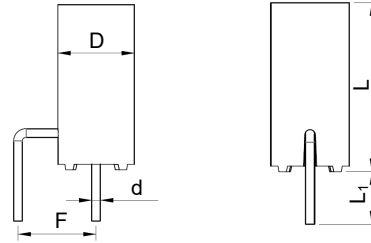

L	L ₁ ^a	D	d	F ^a
11.0 Max.	3.5 ± 0.5	Φ4.8 ± 0.2	Φ0.54 ± 0.05	5.0 ± 0.5

卧式 Horizontal

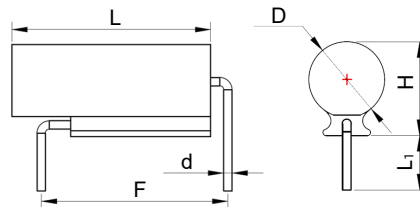

L	L ₁ ^a	H	D	d	F ^a
11.0 Max.	3.5 ± 0.5	6.0 ± 0.2	Φ4.8 ± 0.2	Φ0.54 ± 0.05	10.0 ± 0.5

^a: “F”, “L₁” 可根据需求定制, 折脚方式亦可定制。 “F”, “L₁” and the bending mode of pins can be customized as required.

电性能参数 Electrical Characteristics



项目 Item	参数 Parameter
功率类型 Power Type (P)	1 W
标称阻值 Rated Resistance (R)	1 Ω ~ 800 Ω
阻值公差 Resistance Tolerance	5% (E24), 10% (E12)
降额系数 Derating Factor (f)	详见降额曲线 See Rated Power Derating Curve
实际功率 Actual Power (P ₀)	$P_0 = P \times f$
额定电流 Rated Current (I _N)	$I_N = \sqrt{P_0 / R}$
额定电压 Rated Voltage (U _N)	$U_N = \sqrt{P_0 \times R}$
额定动作温度 Rated Functioning Temp. (T _f)	145 °C, 221 °C
熔断时间 Fusing Time	5 × P (T _f = 221 °C, 小于60 s, less than 60 s)
	3 × P (T _f = 145 °C, 小于60 s, less than 60 s)
实测熔断温度 Fusing Temp.	216 °C ~ 221 °C (T _f = 221 °C)
	138 °C ~ 142 °C (T _f = 145 °C)
浪涌 (仅供参考) Surge (For Reference Only)	2.0 kV (R > 10 Ω)
	1.0 kV (R ≤ 10 Ω)

热保护型熔断电阻器

Thermal-Link & Fusing Resistor (TRXF)

TRXF1 系列 Series

技术参数 Specifications

系列 Series	功率 类型 Power Type	降额系数 Derating Factor (25 °C)	标称阻值 Rated Resistance	阻值公差 Resistance Tolerance	额定动作温度 Rated Functioning Temp. (T _f)	实测熔断 温度 Fusing Temp.	安规认证 Agency Approvals			环保 Environmental Status	
										RoHS	REACH
	(W)	(%)	(Ω)	(%)	(°C)	(°C)	cURus	TUV	CQC		
TRXF1	1	50	0.27 ~ 0.47	± 5, ± 10	145	138 ~ 142	●	N/A	●	●	●
		100			221	216 ~ 221	●	●	●	●	
		50	0.47 ~ 800	± 5, ± 10	145	138 ~ 142	●	●	●	●	●
		100			221	216 ~ 221	●	●	●	●	

阻值选型表 (参照标准: IEC60063-2015, 蓝色字体为赛尔特常规阻值)

Resistance Selection Table (According to IEC60063-2015, blue font is SETsafe | SETfuse common resistance)

标称阻值 Rated Resistance (Ω)	代码 Code	标称阻值 Rated Resistance (Ω)	代码 Code	标称阻值 Rated Resistance (Ω)	代码 Code	标称阻值 Rated Resistance (Ω)	代码 Code
0.10	R10	1.0	1R0	10	10R	100	100R
0.11	R11	1.1	1R1	11	11R	110	110R
0.12	R12	1.2	1R2	12	12R	120	120R
0.13	R13	1.3	1R3	13	13R	130	130R
0.15	R15	1.5	1R5	15	15R	150	150R
0.16	R16	1.6	1R6	16	16R	160	160R
0.18	R18	1.8	1R8	18	18R	180	180R
0.20	R20	2.0	2R0	20	20R	200	200R
0.22	R22	2.2	2R2	22	22R	220	220R
0.24	R24	2.4	2R4	24	24R	240	240R
0.27	R27	2.7	2R7	27	27R	270	270R
0.30	R30	3.0	3R0	30	30R	300	300R
0.33	R33	3.3	3R3	33	33R	330	330R
0.36	R36	3.6	3R6	36	36R	360	360R
0.39	R39	3.9	3R9	39	39R	390	390R
0.43	R43	4.3	4R3	43	43R	430	430R
0.47	R47	4.7	4R7	47	47R	470	470R
0.51	R51	5.1	5R1	51	51R	510	510R
0.56	R56	5.6	5R6	56	56R	560	560R
0.62	R62	6.2	6R2	62	62R	620	620R
0.68	R68	6.8	6R8	68	68R	680	680R
0.75	R75	7.5	7R5	75	75R	750	750R
0.82	R82	8.2	8R2	82	82R	N/A	N/A
0.91	R91	9.1	9R1	91	91R	N/A	N/A

热保护型熔断电阻器

Thermal-Link & Fusing Resistor (TRXF)

TRXF1 系列 Series

降额曲线 (仅供参考) Rated Power Derating Curve (For Reference Only)

当元器件周围的环境温度超过25 °C时，额定功率随环境温度的上升而下降情况如下图所示。
When the ambient temp. exceeds 25 °C, the rated power value declines as the following curve.

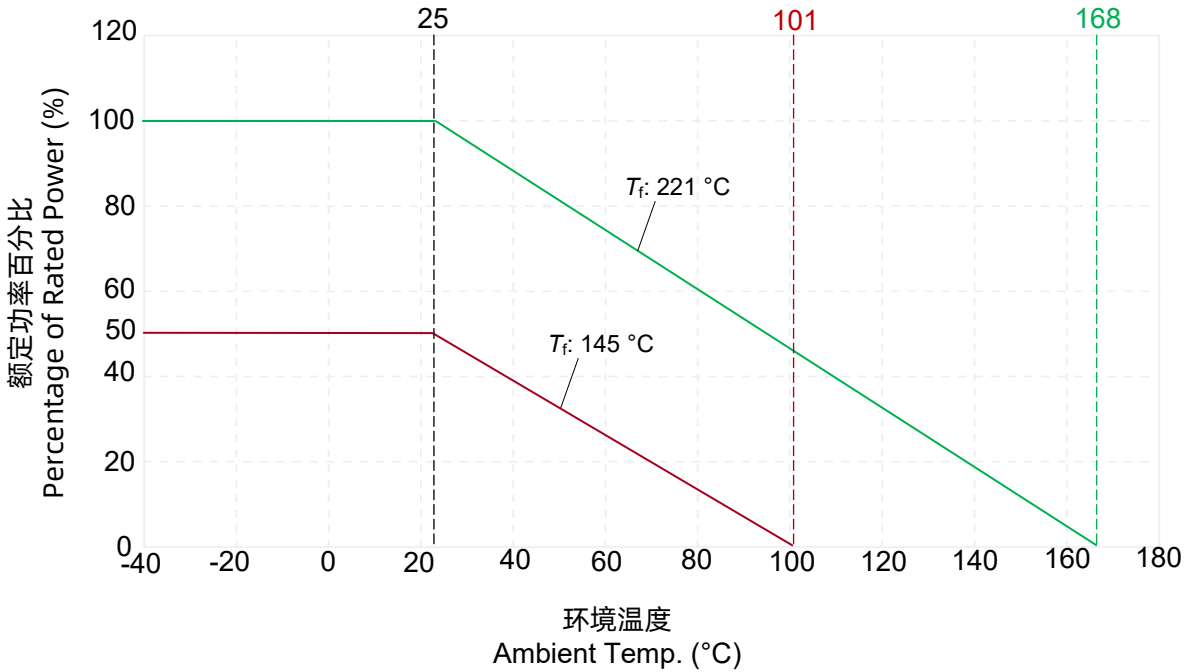

熔断特性曲线 (仅供参考) Fusing Time Curve (For Reference Only)

与线绕熔断电阻器相比，热保护型熔断电阻器在较低的功率倍数下即可有效断开，从而起到及时保护电路的作用（环境温度：25 °C ± 2 °C）。
Compared with RXF, TRXF can open effectively at lower power multiples to protect the circuit timely (ambient temp. 25 °C ± 2 °C).

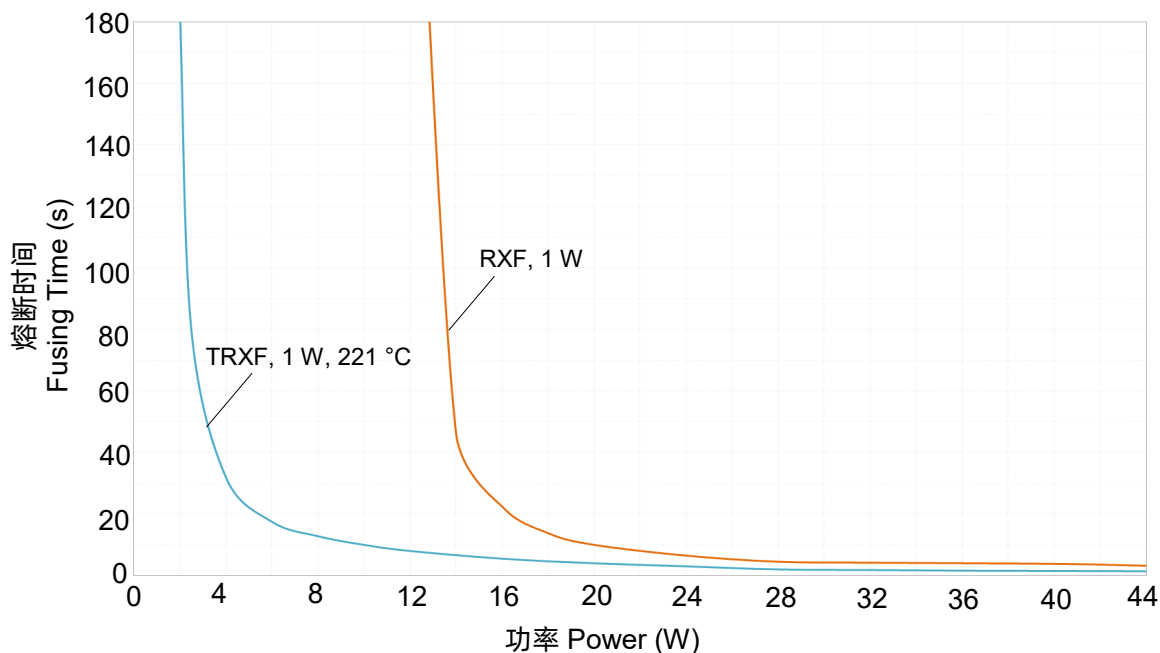

热保护型熔断电阻器

Thermal-Link & Fusing Resistor (TRXF)

TRXF1 系列 Series

表面温度曲线（仅供参考） Surface Temp. Curve (For Reference Only)

热保护型熔断电阻器在熔断之前，其表面温度均处于较低水平，可确保整机出现故障时，热保护型熔断电阻器及时切断电路而不产生附加损伤（环境温度：25 °C ± 2 °C）。

The surface temp. of TRXF is always at a lower level, when small fault current happens to the device, TRXF is able to open the circuit timely without additional damage (ambient temp. 25 °C ± 2 °C).

TRXF表面温度曲线
Surface Temp. Curve of TRXF

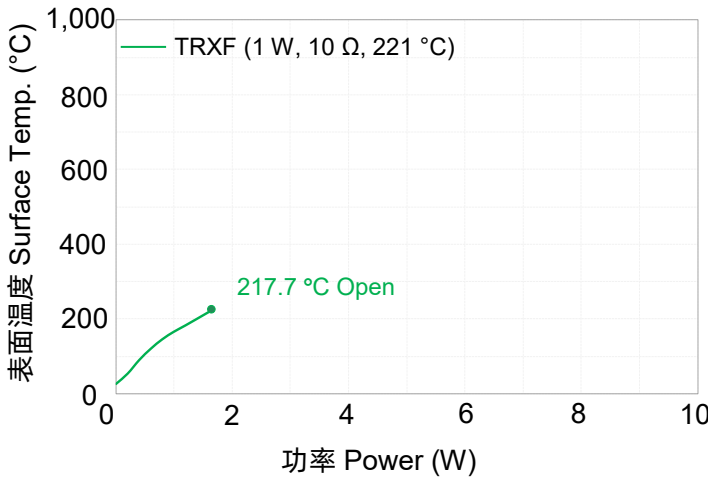

表面温度 (TRXF vs. RXF)
Surface Temp. Curve (TRXF vs. RXF)

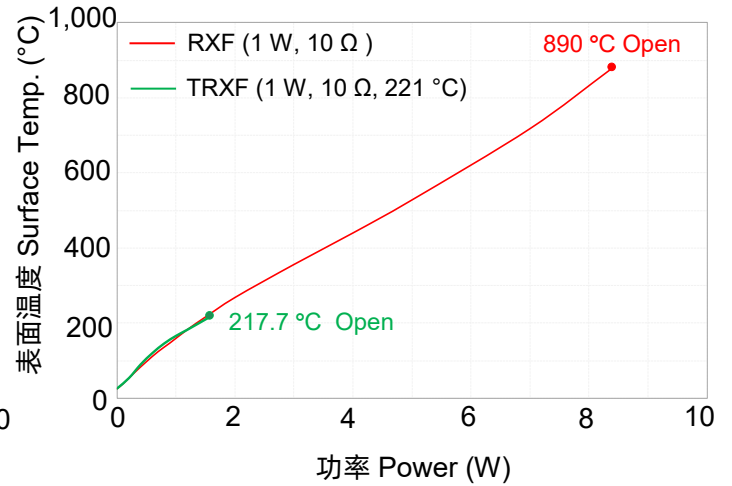

包装信息 Packaging Information

散装 Bulk

项目 Item	小包装袋 PE Bag	内包装盒 Box	外包装箱 Carton
包装尺寸 Dimensions (mm)	135 × 85	255 × 88 × 98	480 × 280 × 230
数量 Quantity (PCS)	100	2,000	20,000
毛重 (立式) Gross Weight (Vertical) (kg)			10.5 ± 10%
毛重 (卧式) Gross Weight (Horizontal) (kg)			12.0 ± 10%

